

Constant Voltage Driver

- The housing is made from V0 flame retardant PC materials from COVESTRO.
- Small size and light weight. Wide range of applicable lamps.
- Class 2 LED driver, Safety Extra Low Voltage (SELV).
- Innovative thermal management technology intelligently protects the life of the LED driver.
- Overheat, overload, short circuit protection and automatic recovery.
- Up to 50,000-hour life time.
- 5-year warranty (AiSHi capacitor).



The certification icon represents on-going certification applications only, and final certification qualification is subject to actual products.



Model	Output Current	Input Current	Input Power	Output Power Range	PF	Typical Efficiency	Output Voltage
S-530-V40W36CG-4B S-530-V40W36CG-4W S-530-V40W36CG-4G	1100mA	0.23A	45.52W	39.6W	0.95	87%	36V

* Test result @230V, 50Hz, Full Load

Parameters







Category	Item	Technical Norm
Features	Output Type	Constant Voltage
	Output Features	Isolation
	IP Grade	IP20
	Insulation Class	Class II(compatible Class I)
Input	Rated Input Voltage	220-240VAC
	Range of Input Voltage	198-264VAC
	Range of DC Input Voltage	180-280VDC
	Frequency	50/60Hz
	Overvoltage protection	2h@380VAC, 48h@320VAC
	Input Current	≤0.23A (230VAC, full load)
	Input Power	≤45.52W (230VAC, full load)
	Power Factor	≥0.95 (230VAC, full load)
	THD	≤20% (230VAC, full load)
	No-load Power Consumption	≤0.50W @230VAC
	Inrush Current	T.B.D (230VAC, full load)
Connected quantity of 10A Breaker	T.B.D@230Vac	
Connected quantity of 13A Breaker	T.B.D@230Vac	
Connected quantity of 16A Breaker	T.B.D@230Vac	
Connected quantity of 20A Breaker	T.B.D@230Vac	

Output	Output Voltage	36VDC+/-5%
	No-load Voltage	35-37VDC
	Output Current	1100mA
	Max. Output Power	39.6W
	Efficiency	≥87% (230VAC, full load)
	Voltage Ripple	2% (Vmax-Vmin) / (Vmax+Vmin)
	Starting Delay Time	≤0.5S (230VAC, full load)
	Pst LM	≤1
	SVM	≤0.4
Protection	Short Circuit Protection	Auto Recovery
	Overload Protection	Auto Recovery (not be hot swap)
	No-load Protection	Auto Recovery
	Insulation voltage	3000V 5mA 60S between P-S
	Insulation resistance	>100M ohm @ 500VDC
	Leakage current	<250μA, I/P to O/P @230V input
Environment	Ta/Operation Temperature	-25....+35 °C
	Ts/Storage Temperature	-25....+75 °C
	Tc/Enclosure Temperature	75 °C
	Humidity	10%....90%RH
	Atmosphere pressure	86-108KPa
Construction	Installation	Independent
	SEC Wire preparation	0.5-1.5 [□]
	Dimension	155*31.1*42.2mm (L*W*H)
Standards	Certification	CE
	Safety Standards	EN61347-1:2015/A1:2021; EN61347-2-13:2014/A1:2017;
	Performance	EN 62384
	Surge	L-N:2kV
Others	RoHs	complied to 2011/65/EU
	Life Time	50000h Tc=75 °C
		75000h Tc=70 °C
		100000h Tc=65 °C
Warranty	5years , F.R. < 10000ppm	
Remark:		
1.All Parameters, if not specified, are measured at 230VAC/50Hz and 25 °C ambient temperature.		
2.LED Driver is a component of the luminaires, Luminaires and wire layout will affect the EMC, please check the EMC with end products again.		

Distance	15m	30m	50m
Cable selection	0.5mm ²	0.75mm ²	1.0mm ²







Label

BLACK (RAL9011)

	LED Driver S-530-V40W36CG-4B For LED modules only Constant Voltage Lighting track adaptors	tc:75 °C ta:35 °C	   
	UN=220-240VAC fN=50/60Hz IN=0.23A Max. PF≥0.95	VOUT=36VDC IOUT=1100mA POUT=39.6W Max. Fmax. 50N ↓	







R Sight B.V.
Roald Dahlilaan
47, 5629 MC, Eindhoven

WHITE (RAL9010)

	LED Driver S-530-V40W36CG-4W For LED modules only Constant Voltage Lighting track adaptors	tc:75 °C ta:35 °C	   
	UN=220-240VAC fN=50/60Hz IN=0.23A Max. PF≥0.95	VOUT=36VDC IOUT=1100mA POUT=39.6W Max. Fmax. 50N ↓	

R Sight B.V.
Roald Dahlilaan
47, 5629 MC, Eindhoven

GRAY (RAL7040)

	LED Driver S-530-V40W36CG-4G For LED modules only Constant Voltage Lighting track adaptors	tc:75 °C ta:35 °C	   
	UN=220-240VAC fN=50/60Hz IN=0.23A Max. PF≥0.95	VOUT=36VDC IOUT=1100mA POUT=39.6W Max. Fmax. 50N ↓	

R Sight B.V.
Roald Dahlilaan
47, 5629 MC, Eindhoven

Dimension (Unit: mm)

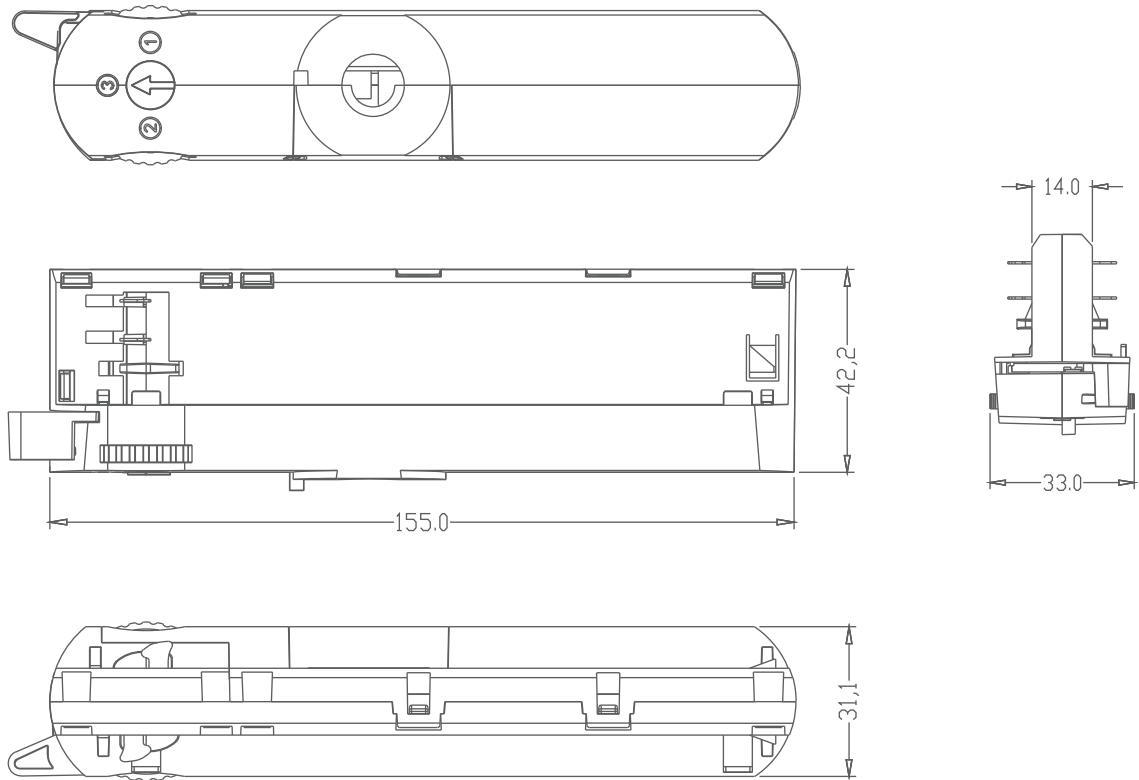

Wiring Diagram

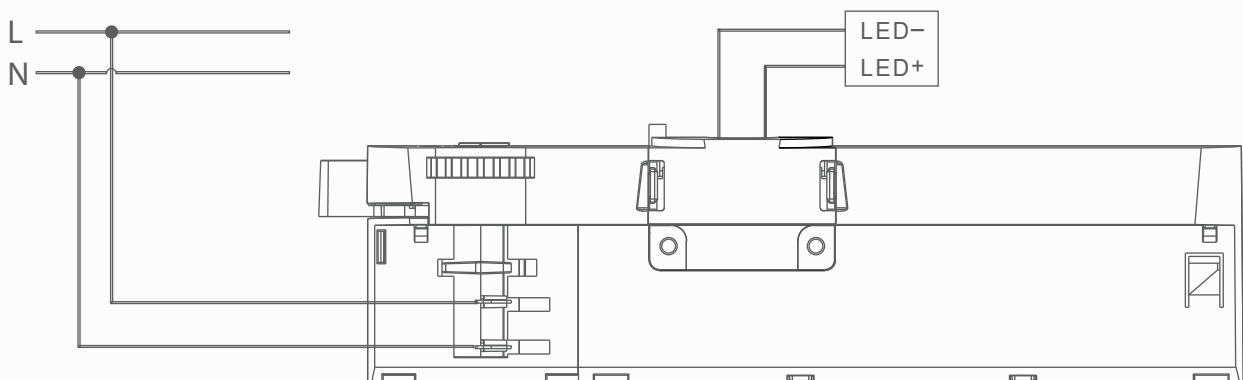

Packing information

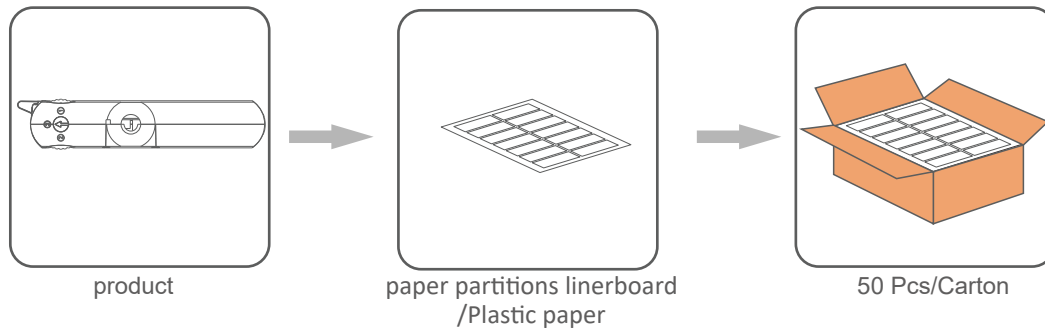

Model	Carton L*W*H(mm)	Pcs/- Carton	Net weight/ Pcs(kg)	Net weight/ Carton(kg)	Cross weight/- Carton(kg)
T.B.D	T.B.D	T.B.D	T.B.D	T.B.D	T.B.D

Lamp Screw Type

- Optional threaded sleeve for luminaire mounting
- Suitable for M10x1x8 threaded nut
- Additional mounting equipment, e.g. M10x1x12
- aluminium, black, white
- further on request

Ordering data 1

Type	Colour	Qty/ctn	Weight/pcs
M10x1x8	White	2500	9.6g
	Black	2500	9.6g
	Grey	2500	9.6g
M10x1x12	White	2500	10.0g
	Black	2500	10.0g
	Grey	2500	10.0g

M10X1X8 (White)

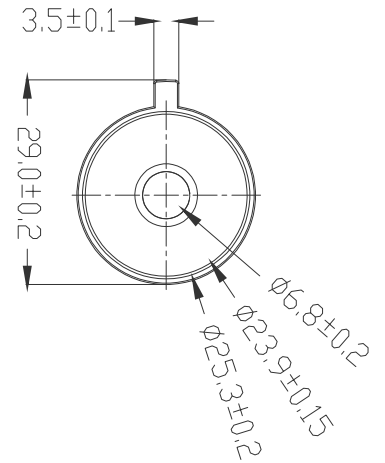
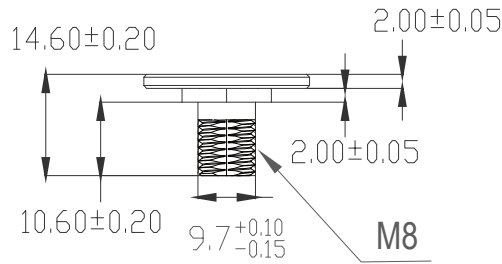

M10X1X12 (White)

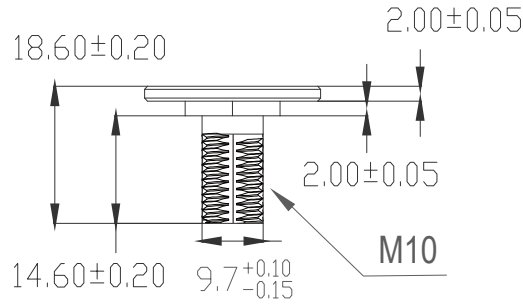

Ordering data 2

Type	Colour	Qty/ctn	Weight/pcs
M10x1x8	White	2500	16.0g
	Black	2500	16.0g
	Primary color	2500	16.0g
M10x1x12	White	2500	16.9g
	Black	2500	16.9g
	Primary color	2500	16.9g

M10X1X8 (Primary color)

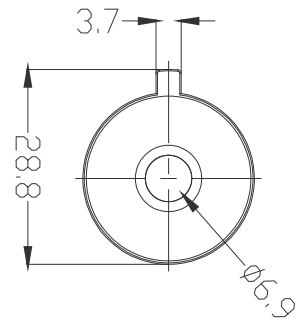
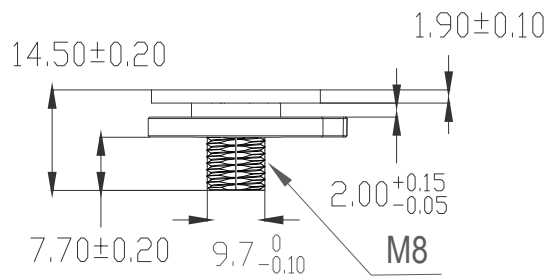

M10X1X12 (Primary color)

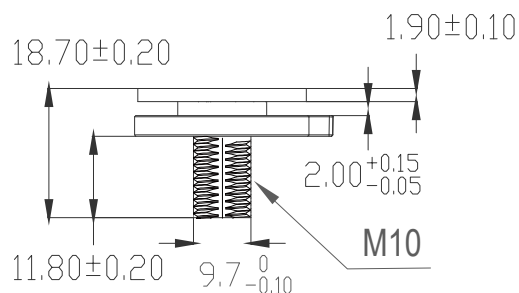

Suitable for following tracks

Serial number	Brand	Track model	Serial number
1	Global	XTS 4&XTSF 4	3P
2	Stucchi	9000XX Series	3P
3	Eutrac	2510x	3P
4	Unipro	T32B	3P
5	Lvela	7501	3P

Remark:

- 1.The model name is XTS 4 and XTSF 4 tracks, and its brand is Global.
- 2.The model name used is the 9000XX track,and its brand is Stucchi.The“XX in the model name represents: it represents a different color.
3. The model name is 2510x tracks, and its brand is Eutrac.The“x”in the model name represents: it represents a different color(x=1white;x=2 black;x=3silverx=8 grey).
4. The model name is T32B tracksand its brand is Unipro.
5. The model name is 7501 tracks, and its brand is lvela.

Phase track light rail specification:

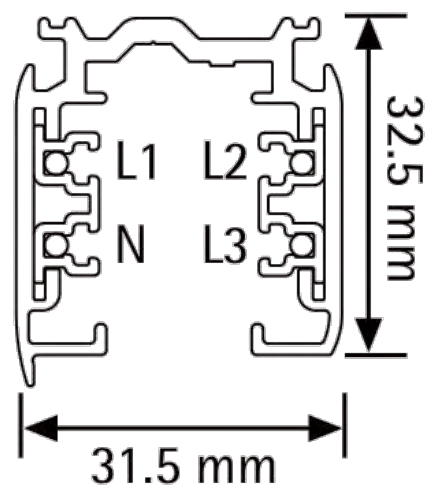
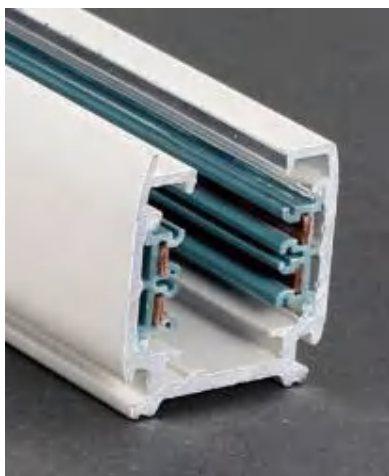

Lighting track adapter and rail system installation diagram:



The adaptor shall be given that the use is limited to the track system specified.

Wiring instructions

All connections must be kept as short as possible to ensure good EMI behaviour

Mains leads should be kept apart from LED Driver and other leads(ideally 5-10 cm distance)

Advice the maximum length of output wires is 3m

Secondary switching is not permitted(Except for constant voltage)·Incorrect wiring can damage LED modules.

The wiring must be protected against short circuits to earth(sharp edged metals parts,metal cable clips, louver, etc.)

REVISION HISTORY

Date	Revision	Remark