

Constant Current Driver

- The housing is made from V0 flame retardant PC materials from COVESTRO.
- Small size and light weight. Wide range of applicable lamps.
- Class 2 LED driver, Safety Extra Low Voltage (SELV).
- Innovative thermal management technology intelligently protects the life of the LED driver.
- Overheat, overload, short circuit protection and automatic recovery.
- Up to 50,000-hour life time.
- 5-year warranty (AiSHi capacitor).



The certification icon represents on-going certification applications only, and final certification qualification is subject to actual products.



Model	Output Current	Input Current	Input Power	Output Power Range	PF	Typical Efficiency	Output Voltage	No load Voltage
S-513-C42W300-1050CG-4B-ED S-513-C42W300-1050CG-4W-ED S-513-C42W300-1050CG-4G-ED	300mA	0.08A	14.48W	3.00-12.60W	0.86	87.2%	10-42V	59V
	350mA	0.09A	16.70W	3.50-14.70W	0.87	88.1%	10-42V	59V
	400mA	0.11A	19.10W	4.00-16.80W	0.88	88.3%	10-42V	59V
	450mA	0.12A	21.48W	4.50-18.90W	0.89	88.6%	10-42V	59V
	500mA	0.13A	23.60W	5.00-21.00W	0.90	89.0%	10-42V	59V
	550mA	0.14A	25.96W	5.50-23.10W	0.91	89.0%	10-42V	59V
	600mA	0.15A	30.40W	6.00-25.20W	0.92	89.0%	10-42V	59V
	650mA	0.16A	30.67W	6.50-27.30W	0.93	89.0%	10-42V	59V
	700mA	0.17A	33.03W	7.00-29.40W	0.94	89.0%	10-42V	59V
	750mA	0.18A	35.40W	7.50-31.50W	0.94	89.0%	10-42V	59V
	800mA	0.20A	37.75W	8.00-33.60W	0.95	89.0%	10-42V	59V
	850mA	0.21A	38.20W	8.50-34.00W	0.95	89.0%	10-40V	59V
	900mA	0.22A	40.45W	9.00-36.00W	0.96	89.0%	10-40V	59V
	950mA	0.22A	42.70W	9.50-38.00W	0.96	89.0%	10-40V	59V
1000mA	0.23A	44.95W	10.00-40.00W	0.97	89.0%	10-40V	59V	
1050mA	0.23A	47.20W	10.50-42.00W	0.97	89.0%	10-40V	59V	

* Test result @230V, 50Hz, Full Load

Parameters

Category	Item	Technical Norm
Features	Output Type	Constant Current
	Output Features	Isolation
	IP Grade	IP20
	Insulation Class	Class II (compatible Class I)
	Rated Input Voltage	220-240VAC
	Range of Input Voltage	198-264VAC
	Range of DC Input Voltage	180-280VDC
	Frequency	50/60Hz
	Overvoltage protection	2h@380VAC, 48h@320VAC
	Input Current	≤0.23A (230VAC, full load)

Input	Input Power	≤47.2W (230VAC, full load)
	Power Factor	≥0.97 (230VAC, full load)
	THD	≤8% (230VAC, full load)
	No-load Power Consumption	≤0.50W @230VAC
	Inrush Current	≤9.5A/16us (230VAC, full load)
	Connected quantity of 10A Breaker Connected quantity of 13A Breaker Connected quantity of 16A Breaker Connected quantity of 20A Breaker	21pcs/type A ;33pcs/type B ;53pcs/type C@230Vac 26pcs/type A ;42pcs/type B ;68pcs/type C@230Vac 33pcs/type A ;53pcs/type B ;84pcs/type C@230Vac 41pcs/type A ;66pcs/type B ;105pcs/type C@230Vac
Output	Output Voltage Range	10-42VDC@300-800mA ; 10-40VDC@850-1050mA
	No-load Voltage	59VDC Max.
	Output Current	300mA-1050mA (Max.output) , Factory set current of 300mA
	Max. Output Power	42W
	Efficiency	≥89.0% (230VAC, full load)
	Output LF current ripple (< 120 Hz)	±3% (Imax-Imin) / (Imax+Imin)
	Current Accuracy	±5%
	Starting Delay Time	≤0.5S (230VAC, full load)
	Pst LM	≤1
	SVM	≤0.4
Protection	Short Circuit Protection	Auto Recovery
	Overload Protection	Auto Recovery (not be hot swap)
	No-load Protection	Auto Recovery
	Insulation voltage	3000V 5mA 60S between P-S
	Insulation resistance	>100M ohm @ 500VDC
	Leakage current	< 700μA, I/P to O/P or I/P @230V input
Environment	Ta/Operation Temperature	-25....+35 C
	Ts/Storage Temperature	-25....+75 C
	Tc/Enclosure Temperature	75 C
	Humidity	10%....90%RH
	Atmosphere pressure	86-108KPa
Construction	Installation	Independent
	SEC Wire preparation	0.3-0.75 [□]
	Dimension	212.7*31.9*36.4mm (L*W*H)
Standards	Certification	CE/ENEC/SAA/UKCA/EAC/CB
	Safety Standards	EN61347-1:2015/A1:2021; EN61347-2-13:2014/A1:2017; EN62384:2006/A1:2009; AS 61347.2.13:2018; AS/NZS61347.1:2016; BS EN61347-1:2015/A1:2021; BS EN61347-2-13:2014/A1:2017; IEC 61347-1-1:2015+A1:2017; IEC 61347-13:2014+A1:2016;
	EMC Standards	AS/NZS CISPR 15:2011; AS CISPR 15:2017;BS EN IEC 55015:2019+A11:2020;EN 61547:2009; BS EN IEC 61000-3-2:2019; BS EN IEC 61000-3-3:2013+A1:2019;
	Performance	EN 62384
	Surge	L/N-Ground:2kV; L-N:1kV
Others	RoHs	complied to 2011/65/EU
	Life Time	50000h Tc=75 C
		75000h Tc=70 C
		100000h Tc=65 C
Warranty	5years , F.R. < 10000ppm	

Remark:

- All Parameters, if not specified, are measured at 230VAC/50Hz and 25 C ambient temperature.
- LED Driver is a component of the luminaires, Luminaires and wire layout will affect the EMC, please check the EMC with end products again.

Distance	15m	30m	50m
Cable selection	0.5mm ²	0.75mm ²	1.0mm ²

Label

BLACK (RAL9011)

Pout [W]	Iout [mA]	A	1	2	3	4	Pout [W]	Iout [mA]	A	1	2	3	4
12.6	300	0.48C-0.93C	-	-	-	-	29.4	700	0.77C-0.97	ON	-	-	-
14.7	350	0.53C-0.95	-	-	-	ON	31.5	750	0.78C-0.98	ON	-	-	ON
16.8	400	0.58C-0.95	-	-	ON	ON	33.6	800	0.80C-0.98	ON	-	ON	ON
18.9	450	0.61C-0.96	-	-	ON	ON	34.0	850	0.81C-0.98	ON	-	ON	ON
21.0	500	0.63C-0.96	-	ON	-	-	36.0	900	0.83C-0.98	ON	ON	-	-
23.1	550	0.66C-0.96	-	ON	-	ON	38.0	950	0.86C-0.98	ON	ON	-	ON
25.2	600	0.70C-0.97	-	ON	ON	-	40.0	1000	0.86C-0.98	ON	ON	ON	-
27.3	650	0.73C-0.98	-	ON	ON	ON	42.0	1050	0.88C-0.98	ON	ON	ON	ON

WHITE (RAL9010)

Pout [W]	Iout [mA]	A	1	2	3	4	Pout [W]	Iout [mA]	A	1	2	3	4
12.6	300	0.48C-0.93C	-	-	-	-	29.4	700	0.77C-0.97	ON	-	-	-
14.7	350	0.53C-0.95	-	-	-	ON	31.5	750	0.78C-0.98	ON	-	-	ON
16.8	400	0.58C-0.95	-	-	ON	ON	33.6	800	0.80C-0.98	ON	-	ON	ON
18.9	450	0.61C-0.96	-	-	ON	ON	34.0	850	0.81C-0.98	ON	-	ON	ON
21.0	500	0.63C-0.96	-	ON	-	-	36.0	900	0.83C-0.98	ON	ON	-	-
23.1	550	0.66C-0.96	-	ON	-	ON	38.0	950	0.86C-0.98	ON	ON	-	ON
25.2	600	0.70C-0.97	-	ON	ON	-	40.0	1000	0.86C-0.98	ON	ON	ON	-
27.3	650	0.73C-0.98	-	ON	ON	ON	42.0	1050	0.88C-0.98	ON	ON	ON	ON

GRAY (RAL7040)

Pout [W]	Iout [mA]	A	1	2	3	4	Pout [W]	Iout [mA]	A	1	2	3	4
12.6	300	0.48C-0.93C	-	-	-	-	29.4	700	0.77C-0.97	ON	-	-	-
14.7	350	0.53C-0.95	-	-	-	ON	31.5	750	0.78C-0.98	ON	-	-	ON
16.8	400	0.58C-0.95	-	-	ON	ON	33.6	800	0.80C-0.98	ON	-	ON	ON
18.9	450	0.61C-0.96	-	-	ON	ON	34.0	850	0.81C-0.98	ON	-	ON	ON
21.0	500	0.63C-0.96	-	ON	-	-	36.0	900	0.83C-0.98	ON	ON	-	-
23.1	550	0.66C-0.96	-	ON	-	ON	38.0	950	0.86C-0.98	ON	ON	-	ON
25.2	600	0.70C-0.97	-	ON	ON	-	40.0	1000	0.86C-0.98	ON	ON	ON	-
27.3	650	0.73C-0.98	-	ON	ON	ON	42.0	1050	0.88C-0.98	ON	ON	ON	ON

Output Current Setting

Output Current	1	2	3	4
300mA	-	-	-	-
350mA	-	-	-	ON
400mA	-	-	ON	-
450mA	-	-	ON	ON
500mA	-	ON	-	-
550mA	-	ON	-	ON
600mA	-	ON	ON	-
650mA	-	ON	ON	ON
700mA	ON	-	-	-
750mA	ON	-	-	ON
800mA	ON	-	ON	-
850mA	ON	-	ON	ON
900mA	ON	ON	-	-
950mA	ON	ON	-	ON
1000mA	ON	ON	ON	-
1050mA	ON	ON	ON	ON

Dimension (Unit: mm)

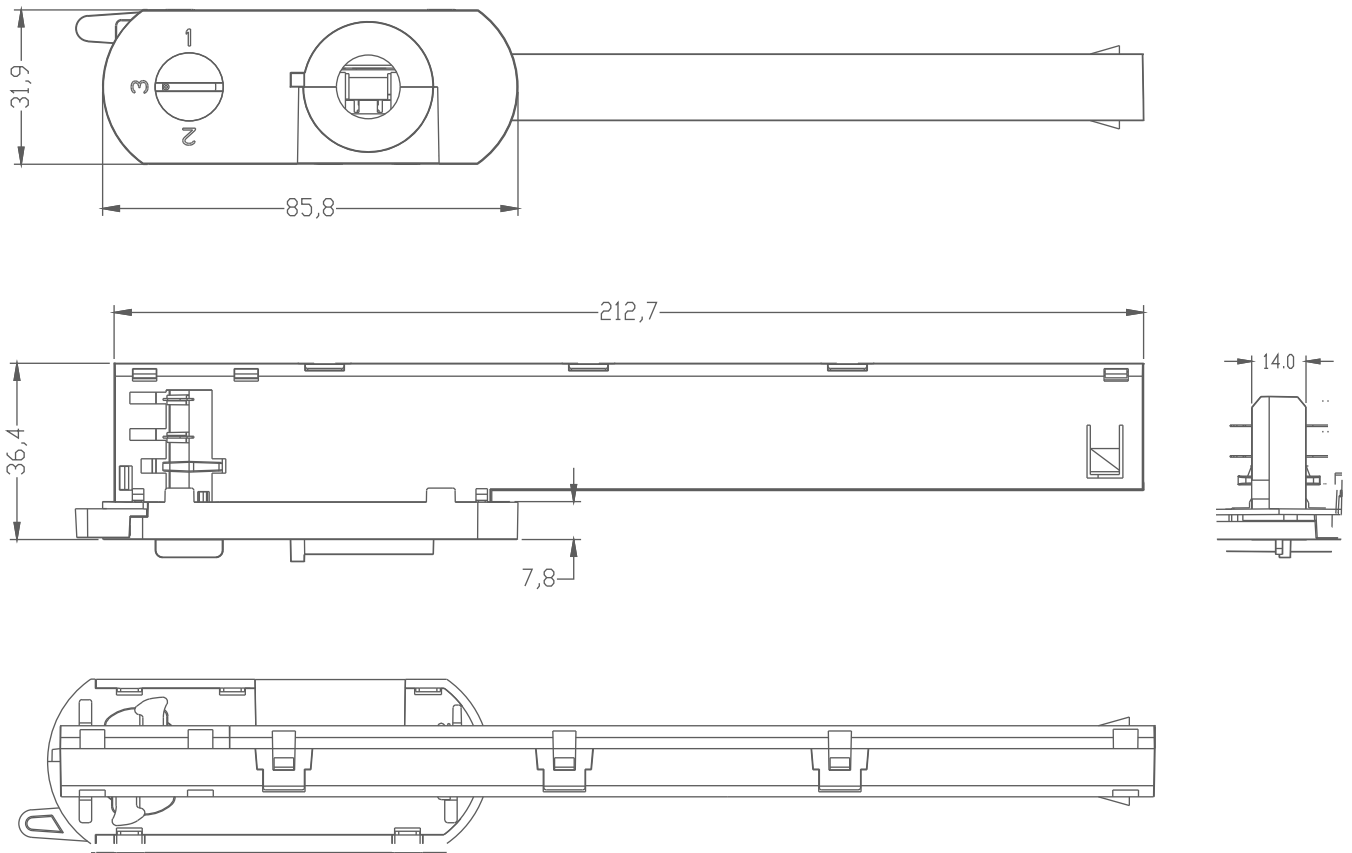

Wiring Diagram

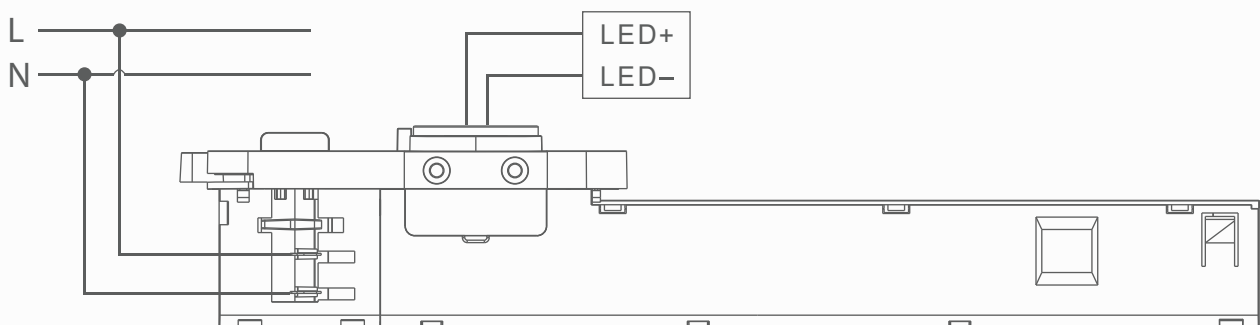

Packing information

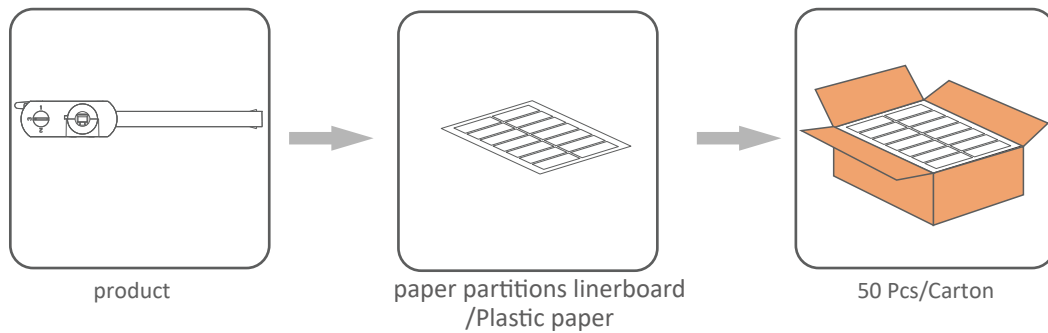

Model	Carton L*W*H(mm)	Pcs/- Carton	Net weight/ Pcs(kg)	Net weight/ Carton(kg)	Cross weight/- Carton(kg)
S-513-C42W300-1050CG-4X-ED	395*295*125	50	0.11	5.60	6.25

Lamp Screw Type

- Optional threaded sleeve for luminaire mounting
- Suitable for M10x1x8 threaded nut
- Additional mounting equipment, e.g. M10x1x12
- aluminium, black, white
- further on request

Ordering data 1

Type	Colour	Qty/ctn	Weight/pcs
M10x1x8	White	2500	9.6g
	Black	2500	9.6g
	Grey	2500	9.6g
M10x1x12	White	2500	10.0g
	Black	2500	10.0g
	Grey	2500	10.0g

M10X1X8 (White)

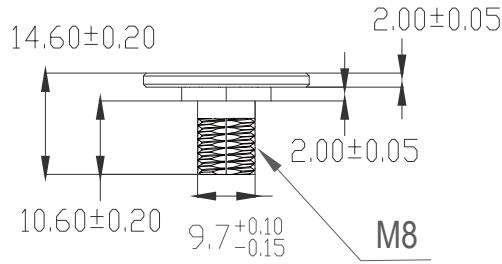

M10X1X12 (White)

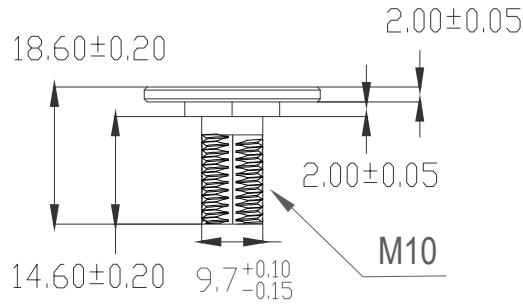

Ordering data 2

Type	Colour	Qty/ctn	Weight/pcs
M10x1x8	White	2500	16.0g
	Black	2500	16.0g
	Primary color	2500	16.0g
M10x1x12	White	2500	16.9g
	Black	2500	16.9g
	Primary color	2500	16.9g

M10X1X8 (Primary color)

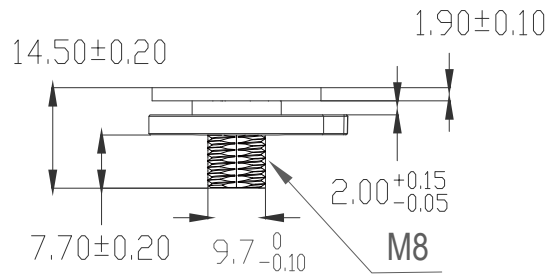

M10X1X12 (Primary color)

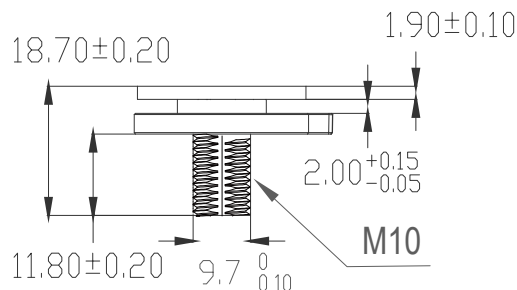
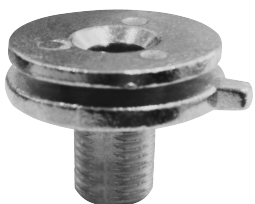

Electrical values

1. Operating power windows

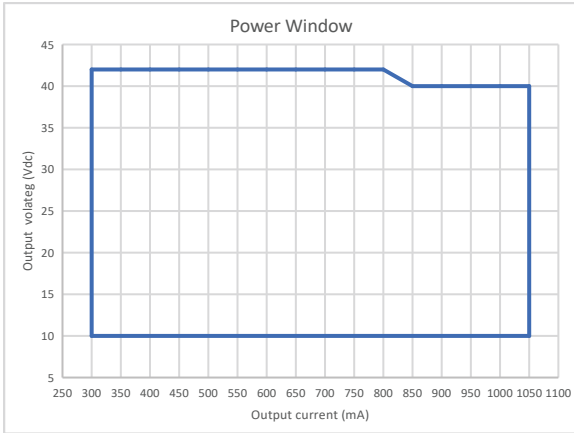

2. Efficiency v.s. Load

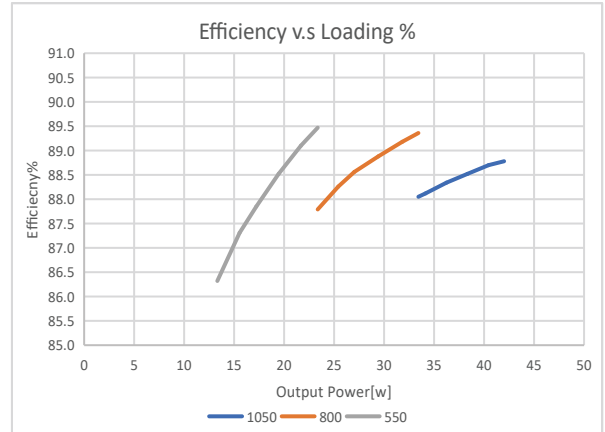

3. PF v.s. Load

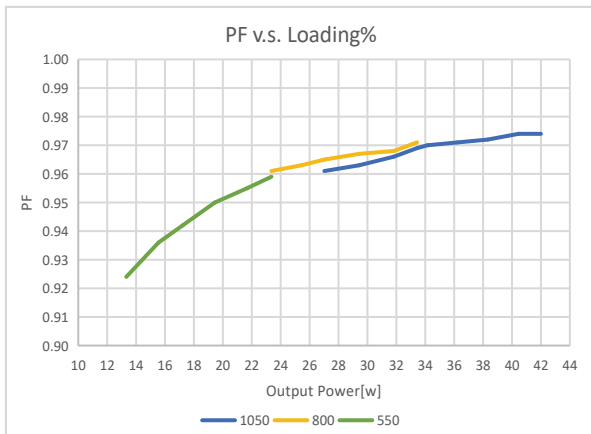

4. THD v.s. Load

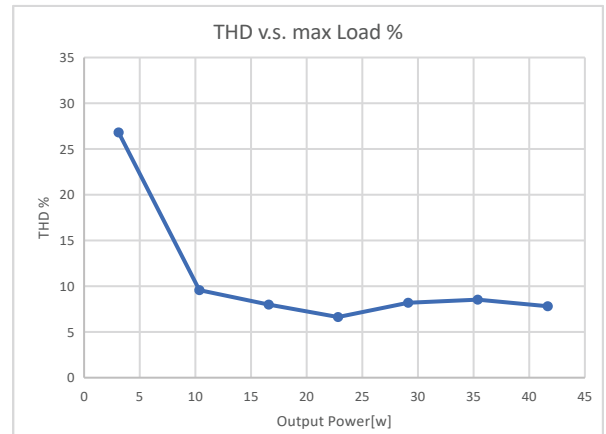

5. Life time

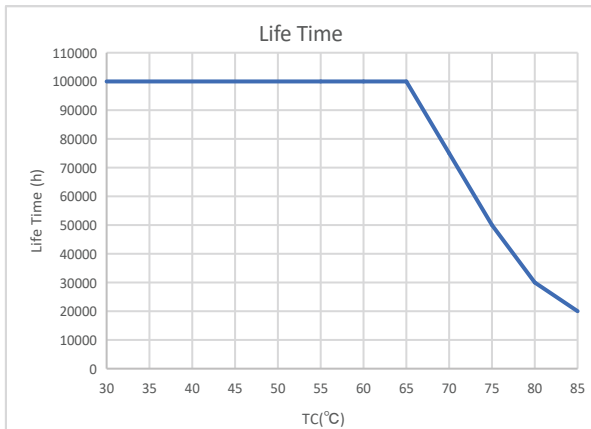

5. Life time

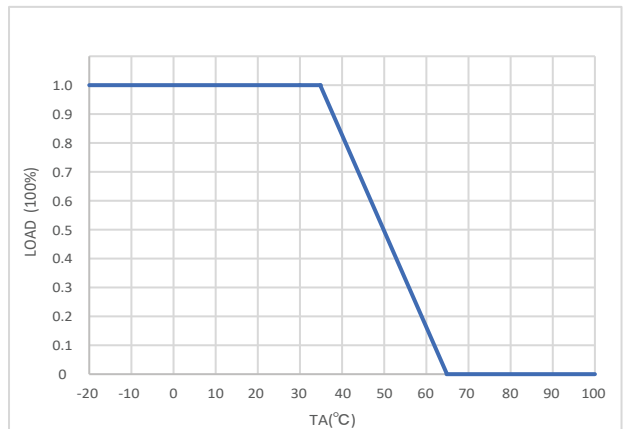

Suitable for following tracks

Serial number	Brand	Track model	Serial number
1	Global	XTS 4&XTSF 4	3P
2	Stucchi	9000XX Series	3P
3	Eutrac	2510x	3P
4	Unipro	T32B	3P
5	Lvela	7501	3P
6	ERCO	ZUMTOBEL	3P

Remark:

1. The model name is XTS 4 and XTSF 4 tracks, and its brand is Global.
2. The model name used is the 9000XX track, and its brand is Stucchi. The "XX" in the model name represents: it represents a different color.
3. The model name is 2510x tracks, and its brand is Eutrac. The "x" in the model name represents: it represents a different color (x=1 white; x=2 black; x=3 silver; x=8 grey).
4. The model name is T32B tracks and its brand is Unipro.
5. The model name is 7501 tracks, and its brand is Lvela.
6. The model name is ZUMTOBEL tracks, and its brand is ERCO.

Phase track light rail specification:

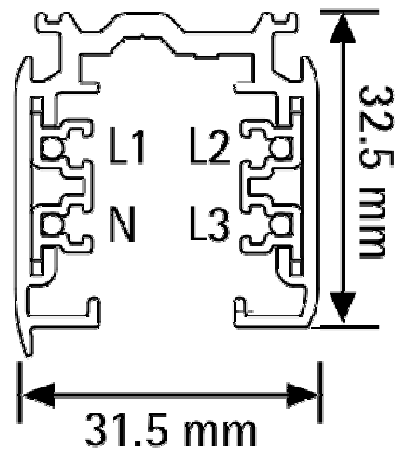
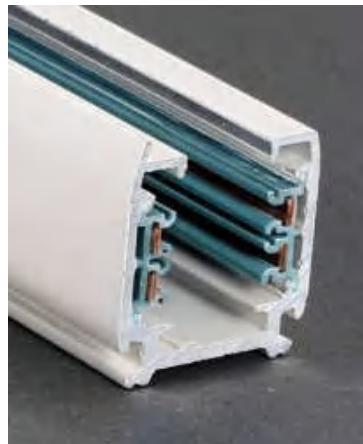

Lighting track adapter and rail system installation diagram:



The adaptor shall be given that the use is limited to the track system specified.

Wiring instructions

- All connections must be kept as short as possible to ensure good EMI behaviour
- Mains leads should be kept apart from LED Driver and other leads(ideally 5-10 cm distance)
- Advice the maximum length of output wires is 3m
- Secondary switching is not permitted(Except for constant voltage)
- Incorrect wiring can damage LED modules.
- The wiring must be protected against short circuits to earth(sharp edged metals parts,metal cable clips, louver, etc.)

REVISION HISTORY

Date	Revision	Remark