

Constant Current Dimmable Driver

- The housing is made from V0 flame retardant PC materials from COVESTRO.
- Small size and light weight. Wide range of applicable lamps.
- Class 2 LED driver, Safety Extra Low Voltage (SELV).
- Innovative thermal management technology intelligently protects the life of the LED driver.
- Overheat, overload, short circuit protection and automatic recovery.
- Up to 50,000-hour life time.
- 5-year warranty (AiSHi capacitor).



The certification icon represents on-going certification applications only, and final certification qualification is subject to actual products.



Model	Output Current	Input Current	Input Power	Output Power Range	PF	Typical Efficiency	Output Voltage	No load Voltage
S-103-C23W100-700 DALI	100mA	0.08A	6.1W	0.25-4.60W	0.78	75%	2.5-46V	60V Max.
	150mA	0.09A	8.6W	0.37-6.90W	0.85	80%		
	200mA	0.10A	11.2W	0.50-9.20W	0.89	82%		
	250mA	0.11A	13.6W	0.62-11.50W	0.91	84%		
	300mA	0.12A	16.0W	0.75-13.80W	0.93	86%		
	350mA	0.13A	18.5W	0.87-16.10W	0.94	87%		
	400mA	0.14A	21.1W	1.00-18.40W	0.94	87%		
	450mA	0.15A	23.5W	1.12-20.70W	0.95	88%		
	500mA	0.16A	26.1W	1.25-23.00W	0.96	88%		
	550mA	0.16A	26.2W	1.37-23.10W	0.96	88%	2.5-42V	
	600mA	0.16A	26.2W	1.50-22.80W	0.96	87%	2.5-38V	
	650mA	0.16A	26.1W	1.62-22.75W	0.96	87%	2.5-35V	
	700mA	0.16A	26.5W	1.75-23.10W	0.96	87%	2.5-33V	

* Test result @230V, 50Hz, Full Load

Parameters

Category	Item	Technical Norm
Features	Output Type	Constant Current
	Dimming Type	DALI 2/ Touch DIM
	Output Features	Isolation
	IP Grade	IP20
	Insulation Class	Class II (compatible Class I)
	Rated Input Voltage	220-240VAC
	Range of Input Voltage	198-264VAC
	Range of DC Input Voltage	180-280VDC
	Frequency	0/50/60Hz, Range:0/47-63Hz
	Overvoltage protection	2h@380VAC, 48h@320VAC
	Input Current	≤0.16A max
	Input Power	≤26.5W max
	Power Factor	≥0.96 (230VAC, full load)
	THD	≤11% (230VAC, full load)
Standby Power Consumption	≤0.45W @230VAC ((DALI system DIM to off)	

Input	Inrush Current	≤7.9A/2.6us (230VAC, full load)
	Connected quantity of 10A Breaker	24pcs/type A ;39pcs/type B ;63pcs/type C@230Vac
	Connected quantity of 13A Breaker	32pcs/type A ;51pcs/type B ;82pcs/type C@230Vac
	Connected quantity of 16A Breaker	39pcs/type A ;63pcs/type B ;101pcs/type C@230Vac
	Connected quantity of 20A Breaker	49pcs/type A ;79pcs/type B ;126pcs/type C@230Vac
Output	Output Voltage Range	2.5-46VDC@100-500mA; 2.5-42VDC@550mA; 2.5-38VDC@600mA; 2.5-35VDC@650mA; 2.5-33VDC@700mA
	No-load Voltage	60VDC Max.
	Output Current	100mA-700mA (Max.output) , Factory set current of 100mA
	Max. Output Power	23.1W
	Efficiency	≥88% 230VAC, full load@max current
	Output LF current ripple (< 120 Hz)	±3% (Imax-Imin) / (Imax+Imin)
	Current Accuracy	±5%
	PSTLM	≤1
	SVM	≤0.4
	Starting Time (AC mode)	≤0.8S (230VAC, full load,by DALI system)
	Starting Time (DC mode)	≤0.4S
	Switching over time (AC/DC)	≤0.4S
Control Method	Secondary PUSH dimming	Secondary PUSH dimming (Max. lead wire length:20m,same port of DALI)
	DALI function	DALI dimming (Max. lead wire length:300m) logarithm or linear dimming curve selectable
	Dimming range	DALI dimming: 1%-100%
	PUSH-button	Max parallel connections qty for Push-dim 15
Protection	Short Circuit Protection	Auto Recovery
	Overload Protection	Auto Recovery (not be hot swap)
	No-load Protection	Auto Recovery
	Insulation voltage	3000V 5mA 60S between P-S
	Insulation resistance	>100M ohm @ 500VDC L/N to PE
	Leakage current	< 700μA, I/P to O/P @230V input
Environment	Ta/Operation Temperature	-20....+50 ℃
	Ts/Storage Temperature	-20....+85 ℃
	Tc/Enclosure Temperature	85 ℃
	Humidity	10%....90%RH
	Atmosphere pressure	86-108KPa
Construction	Connection Method	Push-in Terminal
	Installation	Built-in / Independent
	Dimension	103.4*30*21mm (L*W*H)
	SEC Wire preparation	0.5-1.5 [□] / 8-9mm
	PRI Wire preparation	0.5-1.5 [□] / 8-9mm
	DALI Wire preparation	0.5-1.5 [□] / 8-9mm
Standards	Certification	CE/ENEC/SAA/UKCA/EAC/CB
	Safety Standards	EN61347-1:2015/A1:2021; EN61347-2-13:2014/A1:2017; EN62384:2006/A1:2009; AS 61347.2.13:2018; AS/NZS61347.1:2016; BS EN61347-1:2015/A1:2021; BS EN61347-2-13:2014/A1:2017; IEC 61347-1-1:2015+A1:2017; IEC 61347-13:2014+A1:2016;
	EMC Standards	AS/NZS CISPR 15:2011; AS CISPR 15:2017 ;BS EN IEC 55015:2019+A11:2020;EN 61547:2009; BS EN IEC 61000-3-2:2019; BS EN IEC 61000-3-3:2013+A1:2019;
	DALI performance	EN 62386-101 (DALI-2),EN 62386-102 (DALI-2) EN 62386-207 (DALI-2, including part 251, 252, 253)
	Performance	EN 62384
	Surge	L/N-Ground:2kV; L-N:1kV
Others	RoHs	complied to 2011/65/EU
	Life Time	50000h Tc=85 ℃
		75000h Tc=80 ℃
		100000h Tc=75 ℃
Warranty	5years , F.R. < 10000ppm	

Remark:

- 1.All Parameters, if not specified, are measured at 230VAC/50Hz and 25 °C ambient temperature.
- 2.LED Driver is a component of the luminaires, Luminaires and wire layout will affect the EMC, please check the EMC with end products again.
- 3.Please make sure Tc under Lifetime condition when long term operate under DC input.
- 4.DC emergency (DCemDim):Default 15%, EOFx range = 1 .. 100% (EOFx = DCemDIM level).
- 5.During the PUSH DIM test,the number of parallel connections must be less than 15PCS.

Distance	15m	30m	50m
Cable selection	0.5mm ²	0.75mm ²	1.0mm ²

Output Current Setting

Output Current	1	2	3	4
100mA	-	-	-	-
150mA	-	-	-	ON
200mA	-	-	ON	-
250mA	-	-	ON	ON
300mA	-	ON	-	-
350mA	-	ON	-	ON
400mA	-	ON	ON	-
450mA	-	ON	ON	ON
500mA	ON	-	-	-
550mA	ON	-	-	ON
600mA	ON	-	ON	-
650mA	ON	-	ON	ON
700mA	ON	ON	-	-

Label

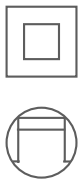

S-103-C23W100-700 DALI
 Constant Current Type for operation with LED modules only
 PRI:220-240VAC 0/50/60Hz Max. 0.16A U-OUT:60V
 SEC:100-700mA 2.5-46VDC ●tc=85°C ta=50°C

LED Dimmable Driver

N | wire preparation (8-9mm)

L PRI: 0.5-1.5°
DALI: 0.5-1.5°
SEC: 0.5-1.5°

DA N

DA L

PUSH-CONTROL

Pout [W]	Iout [mA]	λ	1	2	3	4	Pout [W]	Iout [mA]	λ	1	2	3	4
4.6	100	0.78C	-	-	-	-	20.7	450	0.95	-	ON	ON	ON
6.9	150	0.85C	-	-	-	ON	23.0	500	0.96	ON	-	-	-
9.2	200	0.89C	-	-	ON	-	23.1	550	0.96	ON	-	-	ON
11.5	250	0.91C	-	-	ON	ON	22.8	600	0.96	ON	-	ON	-
13.8	300	0.93C	-	ON	-	-	22.7	650	0.96	ON	-	ON	ON
16.1	350	0.94C	-	ON	-	ON	23.1	700	0.96	ON	ON	-	-
18.4	400	0.94C	-	ON	ON	-	-	-	-	-	-	-	-

Range of application:DC 180-280V

R Sight B.V.
 Roald Dahlaan
 47, 5629 MC, Eindhoven

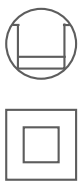

Dimension

Built in type:

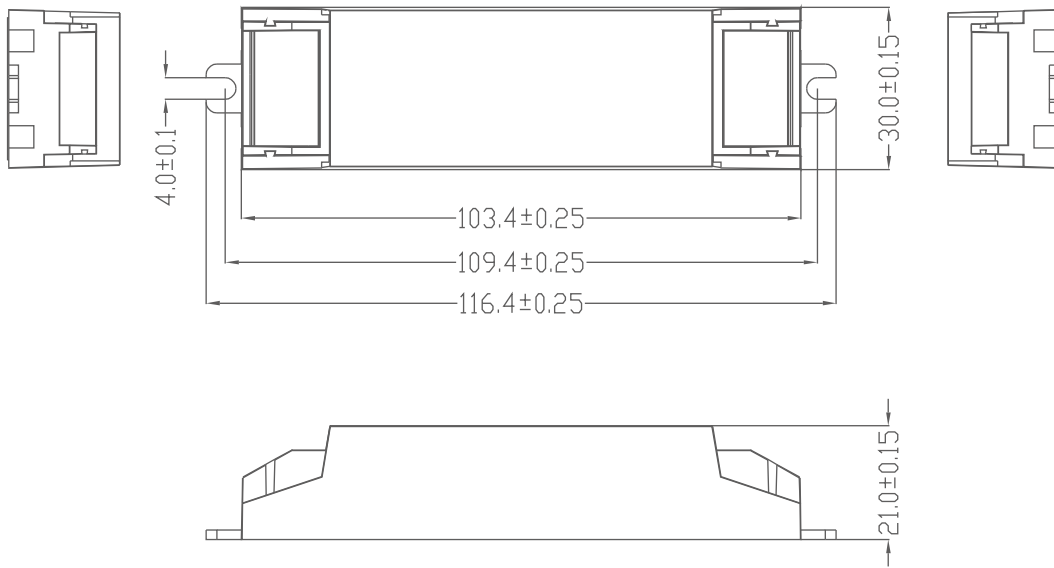

Compatible Small Strain reliefs:SR_CC15-23-36

Compatible Large Strain reliefs:SR_CC15-23-36_5POL

Small side cover

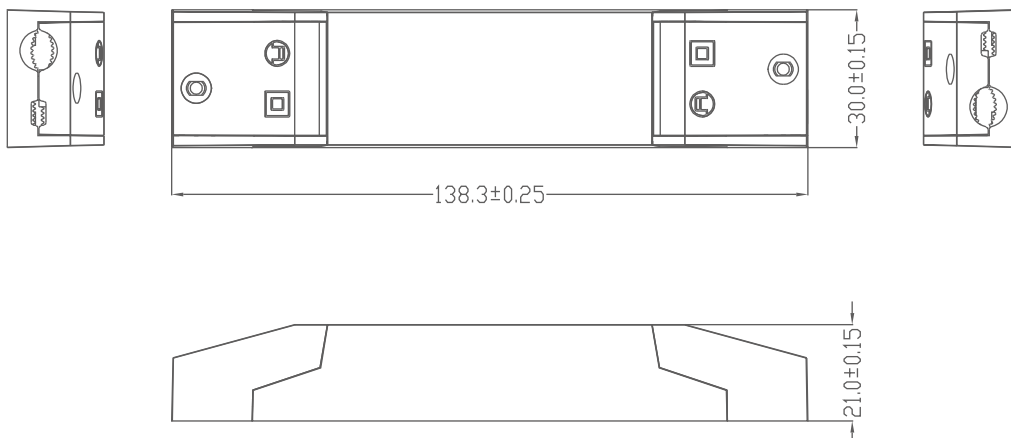

Large side cover

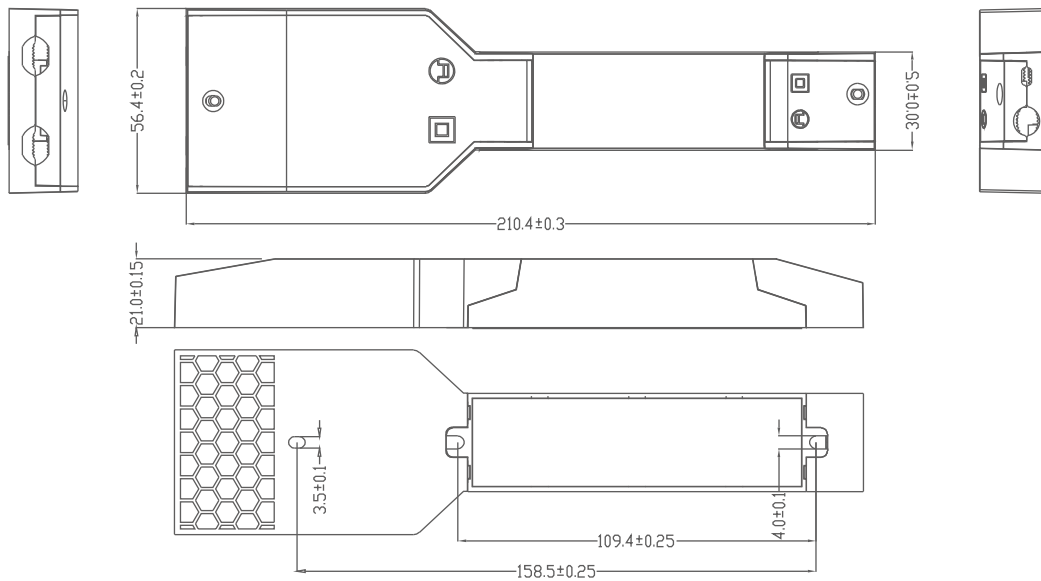

Large side cover specifications

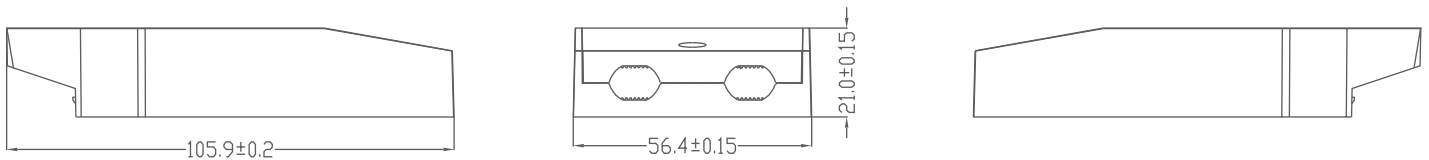

Tolerance for dimensions ± 0.1 mm

Mechanical, Operating & Storage Conditions

Driver cross-section dimensions: 55.4-57.4 x 20.0-22.0 mm

Wire size: 0.5 - 2.5 mm²

Ambient temperature range: -20...+50 °C

Storage temperature range: -20...+85 °C

Assembly temperature range: +5...+30 °C

Do not store in wet or humid environment!

* Unless otherwise stated in the driver datasheet (for independent installation).
Note! Tc max temperature of the driver shall not be exceeded.

Terminal

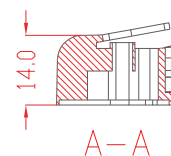
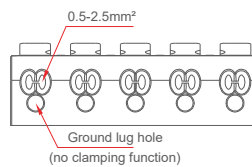
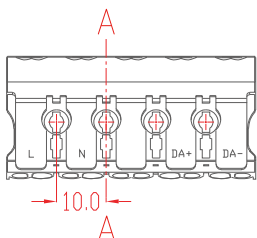

5 - pole connector for DA / CC drivers with LC-SRB-LOOP

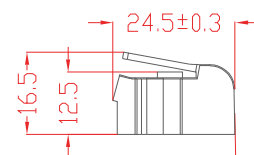
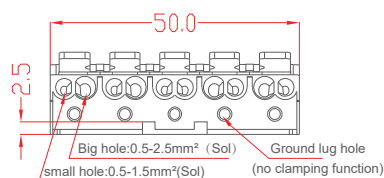

Wiring Diagram

Figure: Voltage peaks for LED driver without earthing (Above) and with earthing (Below)

Fig. A: DALI Dimming

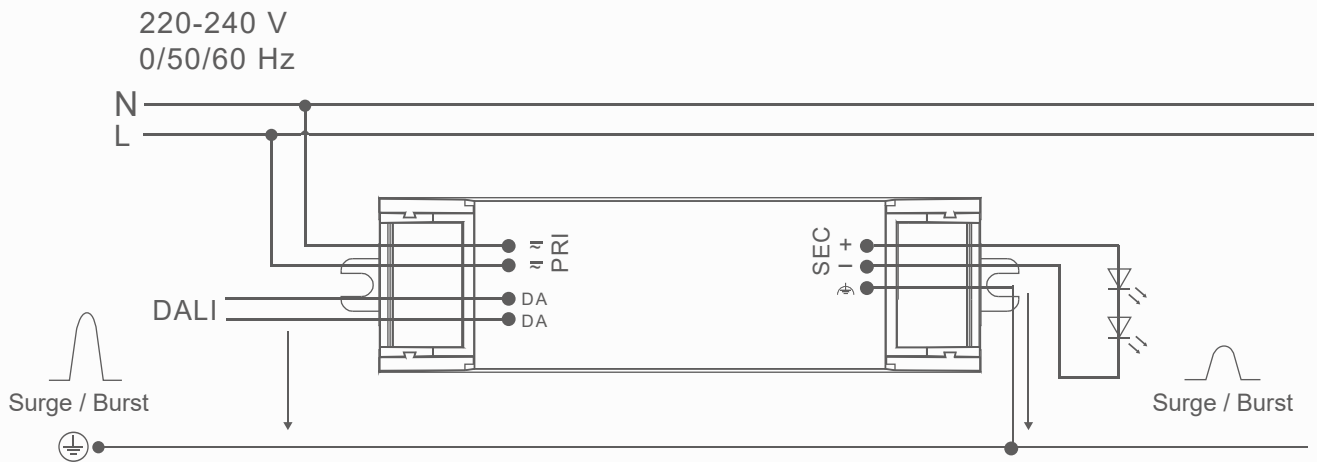
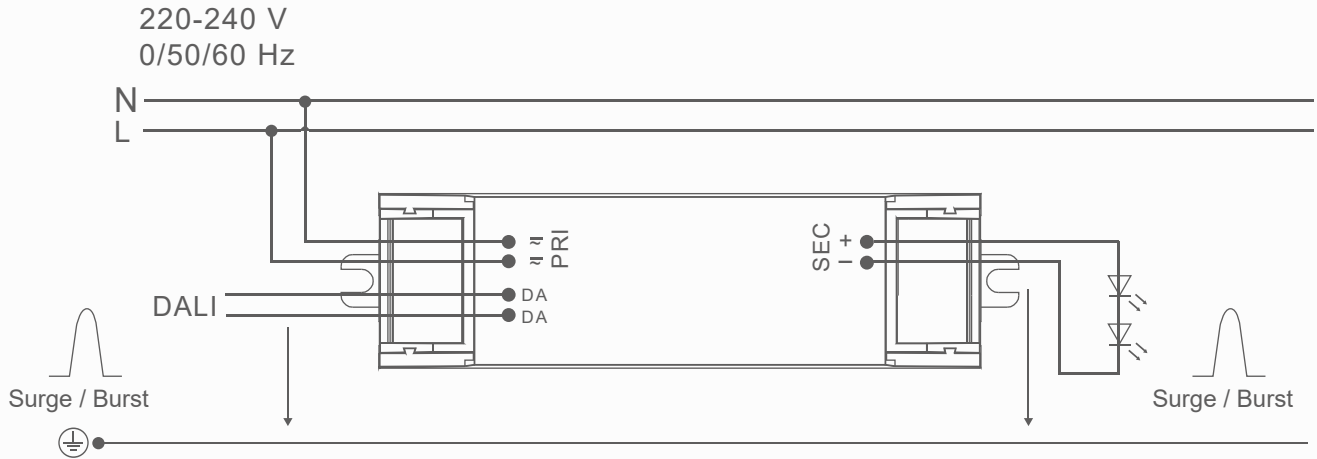
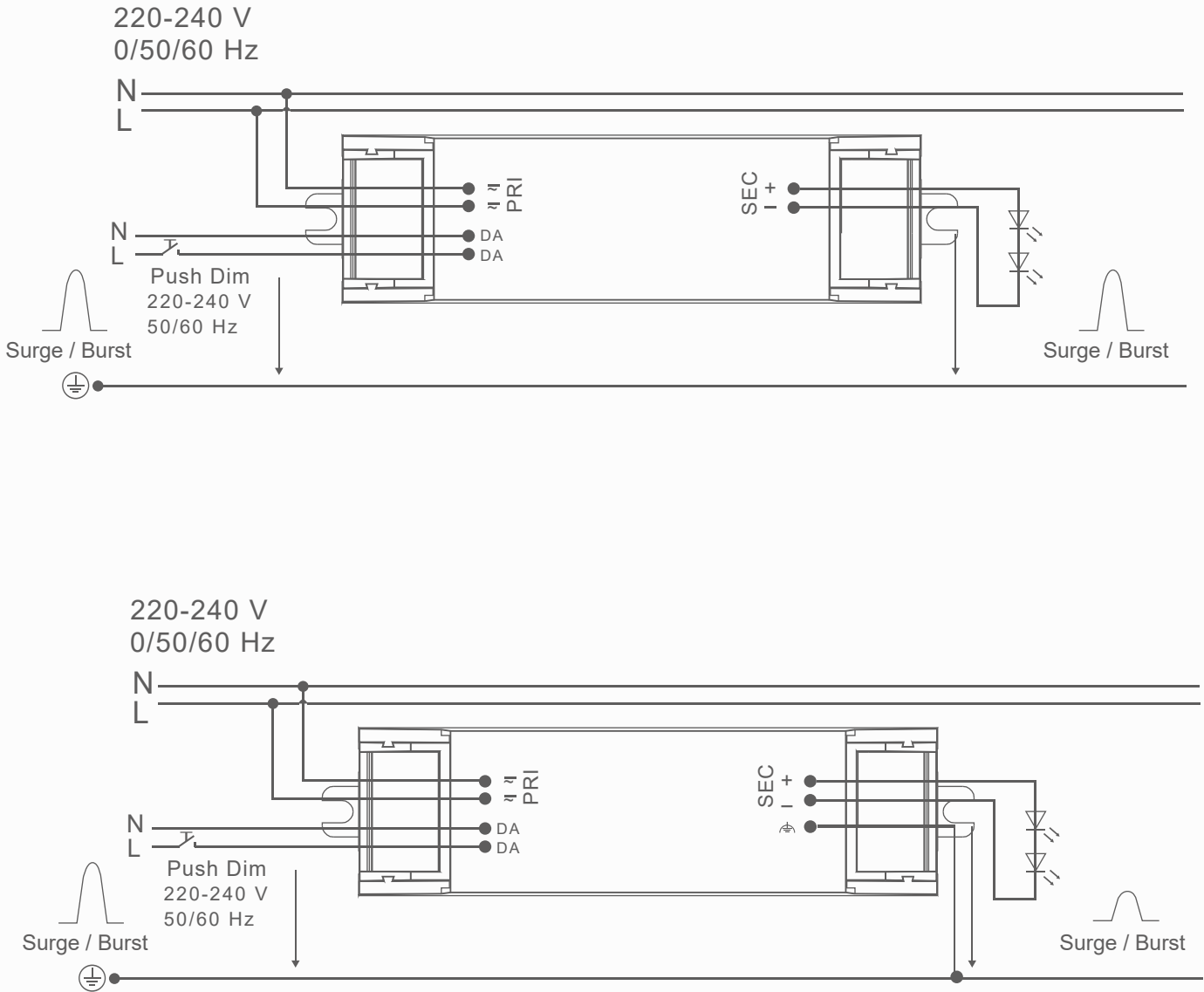

Figure: Voltage peaks for LED driver without earthing (Above) and with earthing (Below)

Fig.B:Push Dimming



Electrical values

1. Operating power windows

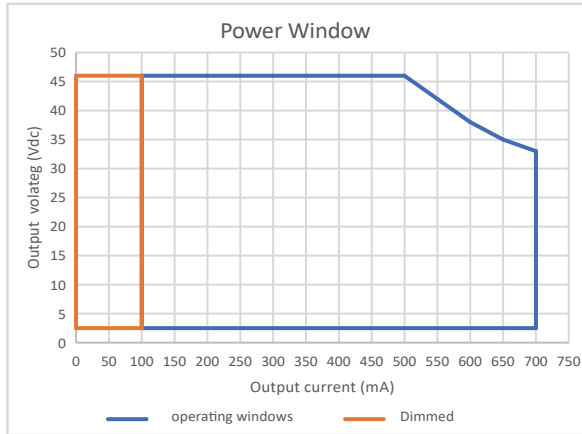

2. Efficiency v.s. Load

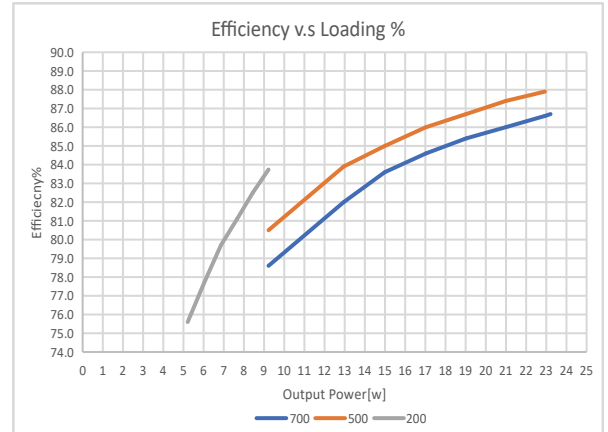

3. PF v.s. Load

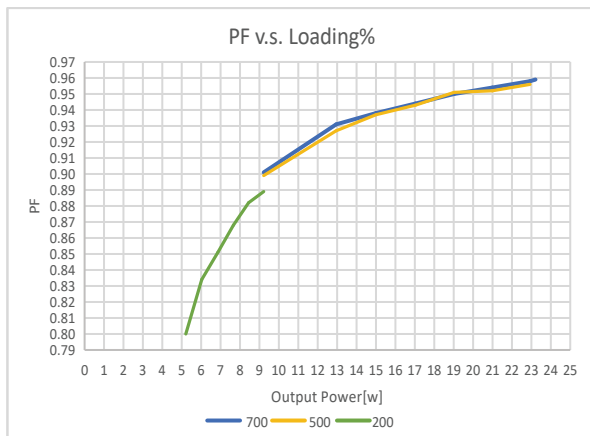

4. THD v.s. Load

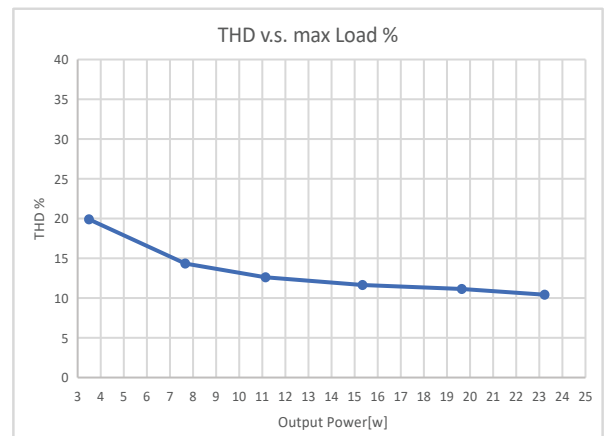

5. Life time

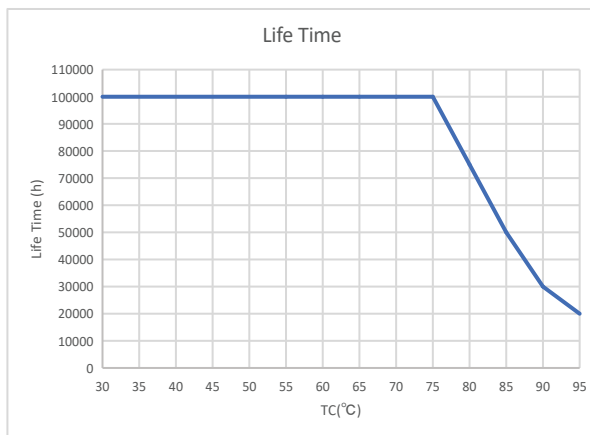

6. Derating

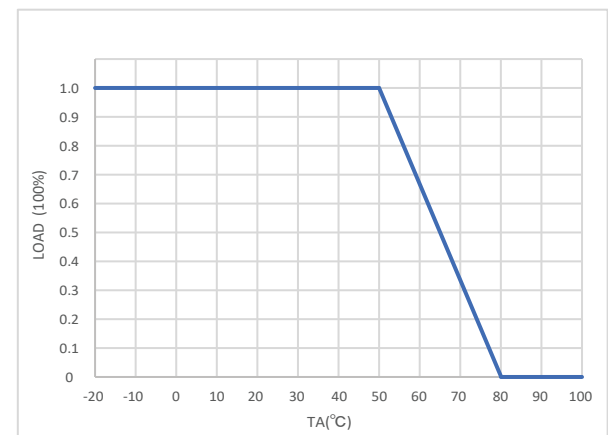

DALI dimming curve

formula for DALI dimming.

$$X(n)=10^{\{[(n-1)/(253/3)]-1\}},$$

Here, n means the target dimming stage of the total 254 stages.

X(n) means the percent of the maximum output current

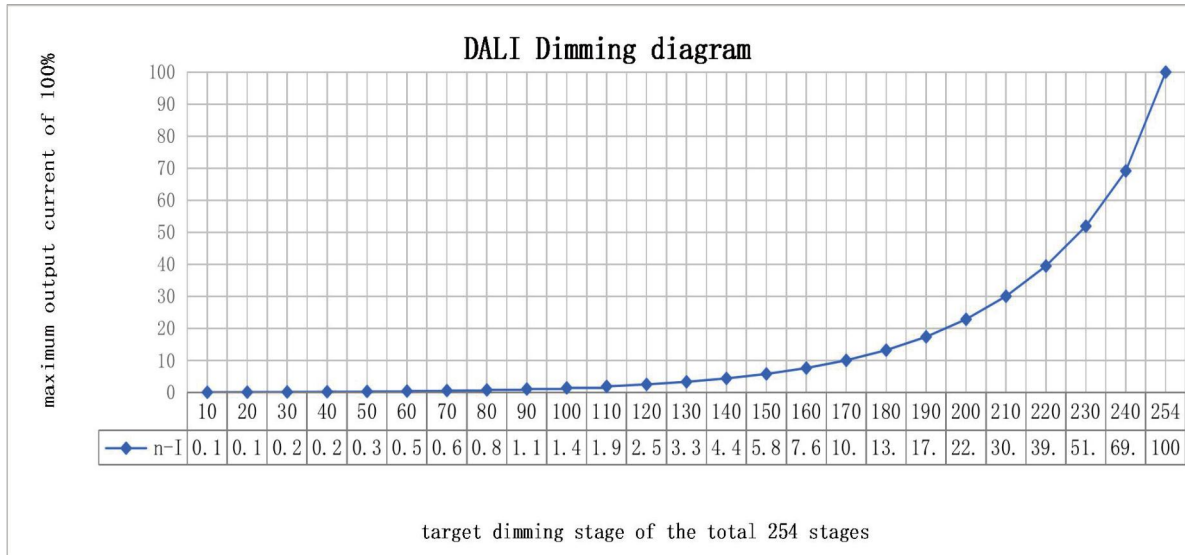

Function of the earth terminal:



The earth connection is conducted as protection earth (PE). The LED Driver can be earthed via earth terminal or metal housing

(if device has metal housing). If the LED Driver will be earthed, protection earth (PE) has to be used. There is no earth connection required for the functionality of the LED Driver. Earth connection is recommended to improve following behaviour.

- Electromagnetic interferences (EMI)
- LED glowing at standby

In general, it is recommended to earth the LED Driver if the LED module is mounted on earthed luminaire parts respectively heat sinks and thereby representing a high capacity against earth. Avoiding residual LED glow on standby

Residual LED glow on standby may occur as a result of capacitive leakage currents from the LED module onto earthed luminaire parts (such as the heat sink). This mainly affects high-efficiency LED systems with large surface areas installed in luminaires with protection class 1.

The topology has been improved so that residual LED glow can be virtually eliminated by earthing the devices.

Packing information

Built in type

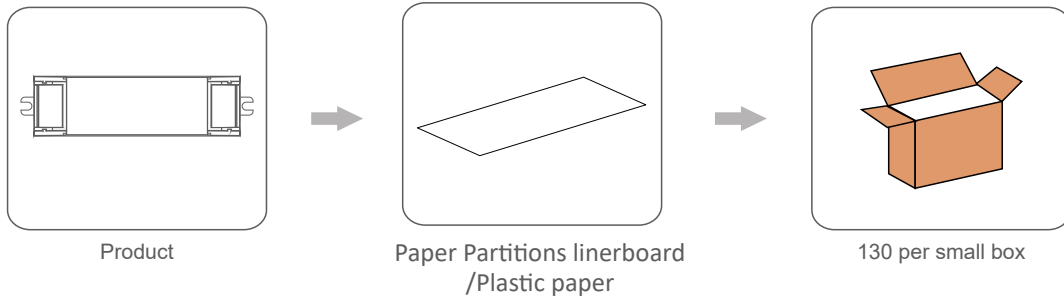

Model	Carton L*W*H(mm)	Pcs/- Carton	Net weight/ Pcs(kg)	Net weight/ Carton(kg)	Cross weight/- Carton(kg)
S-103-C23W100-700 DALI	398*230*130	130	0.072	9.38	9.88

Small Strain reliefs

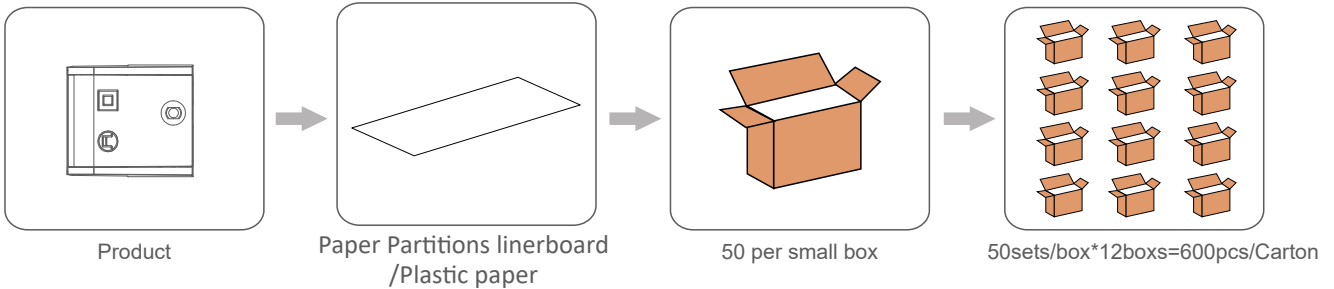

Model	Carton L*W*H(mm)	Pcs/- Carton	Net weight/ Pcs(kg)	Net weight/ Carton(kg)	Cross weight/- Carton(kg)
S-103-C23W100-700 DALI	500*195*245	600	0.007	4.26	5.56

Large Strain reliefs

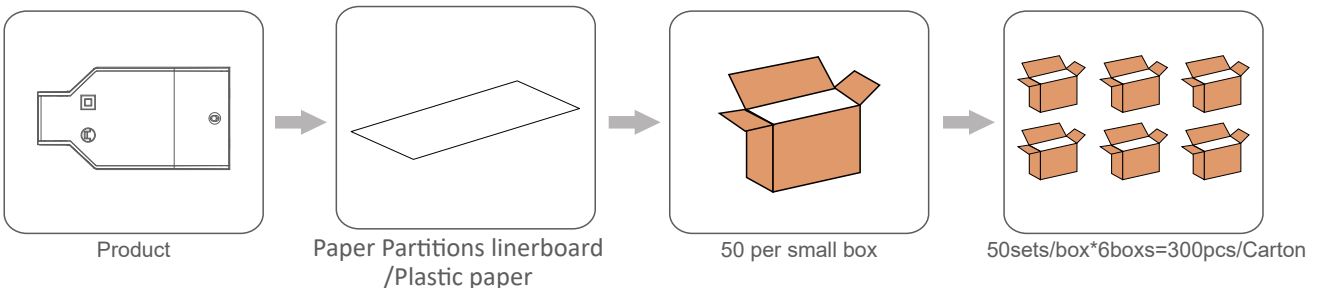

Model	Carton L*W*H(mm)	Pcs/- Carton	Net weight/ Pcs(kg)	Net weight/ Carton(kg)	Cross weight/- Carton(kg)
S-103-C23W100-700 DALI	375*315*385	300	0.041	12.34	13.9

Push Dim :

1.On / off:

Short push (120ms-600ms) on the switch, Stepless dimming: long push (> 0.6sec) on the switch.

2.Power-on memory function

When the LED driver is powered on, it will restore the memory before the LED driver is powered off.

(brightness remembers the brightness after the last dimming is stable, and the brightness during dimming is not memorized)

3.Light on/off

If the light is on, the light will be off after a short press. If the light is off, the light will be on after a short press.

The time range of short press is 120-600ms.

4.PUSH Dimming

Press and hold the push switch for a long time, the light will enter the dimming state, if the previous time is dimming, it will automatically turn to dimming the next time. After releasing the reset button, the dimming stops and the current illuminance is maintained. The dimming range is 1%-100%. The default is to dim when the power is first long-press. If the brightness of the power-on is the maximum brightness, the first long-press is to dim. (Long press 0.6-3S to start dimming.)

5.Forced synchronization

Long press for 10 seconds to turn on all the lights and turn on the same brightness (50%), and continue to quickly short press will not change. After a short period of time without short press operation, the module exits the synchronization mode, and the short press restores the switch function.

6.PUSH Dimming rate

Long press the push switch 10S to switch the dimming rate to 3S, Long press the push switch 20S to switch the dimming rate to 6S.

REVISION HISTORY

Date	Revision	Remark