

Constant Current Driver

- The housing is made from V0 flame retardant PC materials from COVESTRO.
- Small size and light weight. Wide range of applicable lamps.
- Class 2 LED driver, Safety Extra Low Voltage (SELV).
- Innovative thermal management technology intelligently protects the life of the LED driver.
- Overheat, overload, short circuit protection and automatic recovery.
- Up to 50,000-hour life time.
- 5-year warranty (AiSHi capacitor).

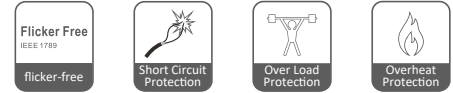

The certification icon represents on-going certification applications only, and final certification qualification is subject to actual products.



Model	Output Current	Input Current	Input Power	Output Power Range	PF	Typical Efficiency	Output Voltage	No load Voltage
S-086-C10W100-700 NFC	100-700mA	≤0.07A	11.9W	0.25-10.00W	≥0.92	84%	2.5-46Vdc	56Vdc

* Test result @230V, 50Hz, Full Load

Parameters

Category	Item	Technical Norm
Features	Output Type	Constant Current
	Output current setting	Near field communication (NFC)
	Output Features	Isolation
	IP Grade	IP20
	Insulation Class	Class II
Input	Rated Input Voltage	220-240VAC
	Range of Input Voltage	198-264VAC
	Range of DC Input Voltage	180-280VDC
	Frequency	0/50/60Hz, Range:0/47-63Hz
	Overvoltage protection	2h@380VAC, 48h@320VAC
	Input Current	≤0.07A max
	Input Power	≤11.9W max
	Power Factor	≥0.92 (230VAC, full load)
	THD	≤11% (230VAC, full load)
	No-load Power Consumption	≤0.5W (230VAC, full load)
	Inrush Current	≤6.9A/2.6us (230VAC, full load)
Connected quantity of 10A Breaker	28pcs/type A ;45pcs/type B ; 72pcs/type C @ 230Vac	
Connected quantity of 13A Breaker	36pcs/type A ;58pcs/type B ; 94pcs/type C @ 230Vac	
Connected quantity of 16A Breaker	45pcs/type A;72pcs/type B ; 115pcs/type C @ 230Vac	
Connected quantity of 20A Breaker	56pcs/type A;90pcs/type B ; 144pcs/type C @ 230Vac	

Output	Output Voltage Range	2.5-46VDC@100-200mA; 2.5-40VDC@250mA; 2.5-33VDC@300mA; 2.5-28VDC@350mA; 2.5-25VDC@400mA; 2.5-22VDC@450mA; 2.5-20VDC@500mA; 2.5-18VDC@550mA; 2.5-16VDC@600mA; 2.5-15VDC@650mA; 2.5-14VDC@700mA
	No-load Voltage	56VDC Max.
	Output Current	100mA-700mA (by NFC setting, Factory set current of 100mA)
	Max. Output Power	10.0W
	Efficiency	≥84% (230VAC, full load@max current)
	Output LF current ripple (< 120 Hz)	±3% (Imax-Imin) / (Imax+Imin)
	Current Accuracy	±5%
	PstLM	≤1
	SVM	≤0.4
	Starting Time (AC mode)	≤0.5S (230VAC, full load,)
Control Method	NFC current setting	The output current can be set within the total value range in 1-mA-steps. Output current is mean value. Setting is by SGN's software APP/APK/PC with FEIG equipment or mobile phone.
Protection	Short Circuit Protection	Auto Recovery
	Overload Protection	Auto Recovery (not be hot swap)
	No-load Protection	Auto Recovery
	Insulation voltage	3000V 5mA 60S between P-S
	Insulation resistance	>100M ohm @ 500VDC
	Leakage current	< 700μA, I/P to O/P @230V input
Environment	Ta/Operation Temperature	-20....+50 °C
	Ts/Storage Temperature	-20....+85 °C
	Tc/Enclosure Temperature	85 °C
	Humidity	10%....90%RH
	Atmosphere pressure	86-108KPa
Construction	Installation	Built -in / Independent
	Dimension	86*30*21mm (L*W*H)
	SEC Wire preparation	0.5-1.5 [□] / 8-9mm
	PRI Wire preparation	0.5-1.5 [□] / 8-9mm
Standards	Certification	CE
	Safety Standards	EN61347-1:2015/A1:2021; EN61347-2-13:2014/A1:2017;
	Performance	EN 62384
	Surge	L/N-Ground:2kV; L-N:1kV
Others	RoHs	2011/65/EU
	Life Time	50000h Tc=85 °C
		75000h Tc=80 °C
		100000h Tc=75 °C
Warranty	5years , F.R. < 10000ppm	
Remark:		
1.All Parameters, if not specified, are measured at 230VAC/50Hz and 25 °C ambient temperature.		
2.LED Driver is a component of the luminaires, Luminaires and wire layout will affect the EMC, please check the EMC with end products again.		

Distance	15m	30m	50m
Cable selection	0.5mm ²	0.75mm ²	1.0mm ²

Label

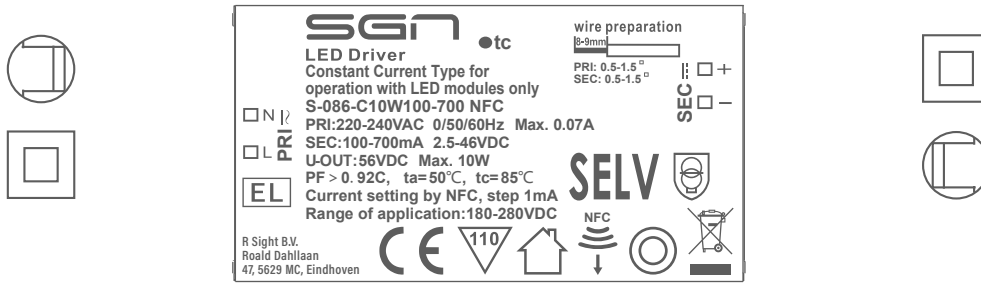

Dimension

Built in type:

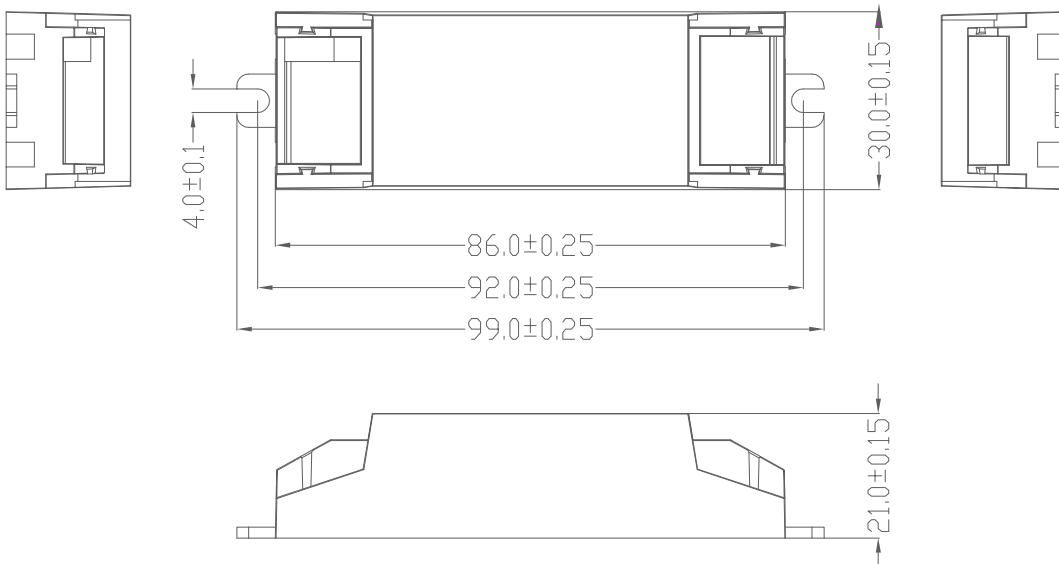

Compatible Small Strain reliefs: SR_CC15-23-36

Compatible Large Strain reliefs: SR_CC15-23-36_3POL

Small Strain reliefs

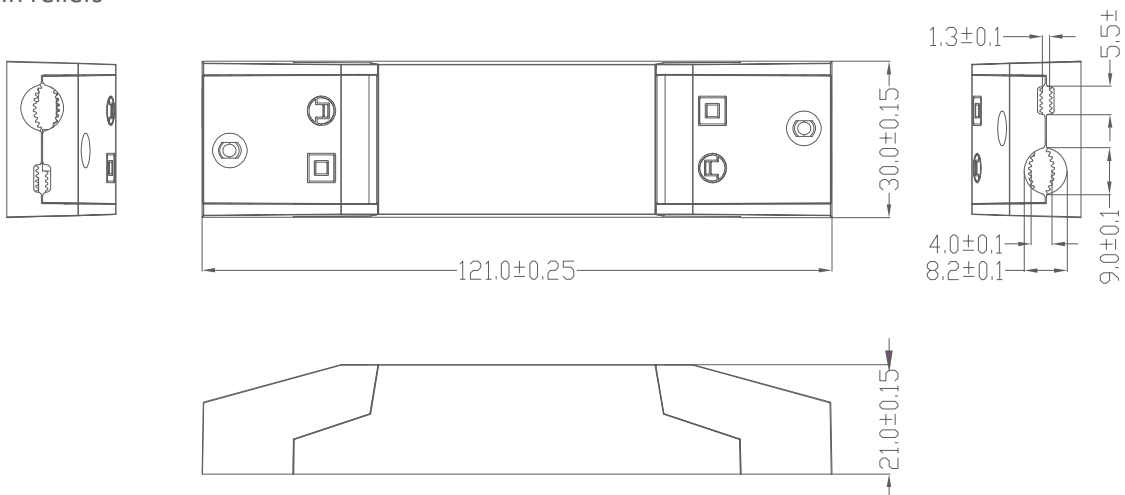

Large side cover

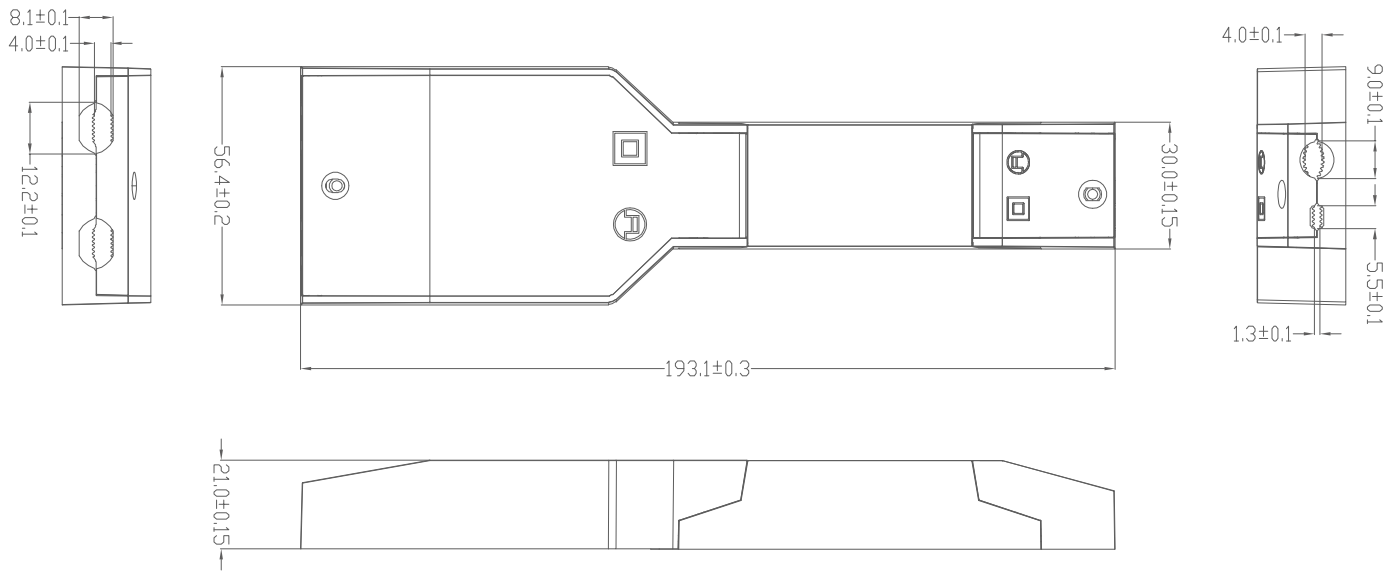

Large side cover specifications

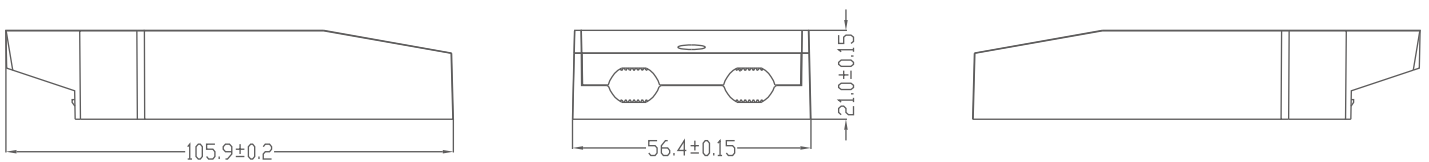

Tolerance for dimensions ± 0.1 mm

Mechanical, Operating & Storage Conditions

Driver cross-section dimensions: 55.4-57.4 x 20.0-22.0 mm

Wire size: 0.5 - 2.5 mm²

Ambient temperature range: -20...+50 °C

Storage temperature range: -20...+85 °C

Assembly temperature range: +5...+30 °C

Do not store in wet or humid environment!

* Unless otherwise stated in the driver datasheet (for independent installation).
Note! Tc max temperature of the driver shall not be exceeded.

Terminal

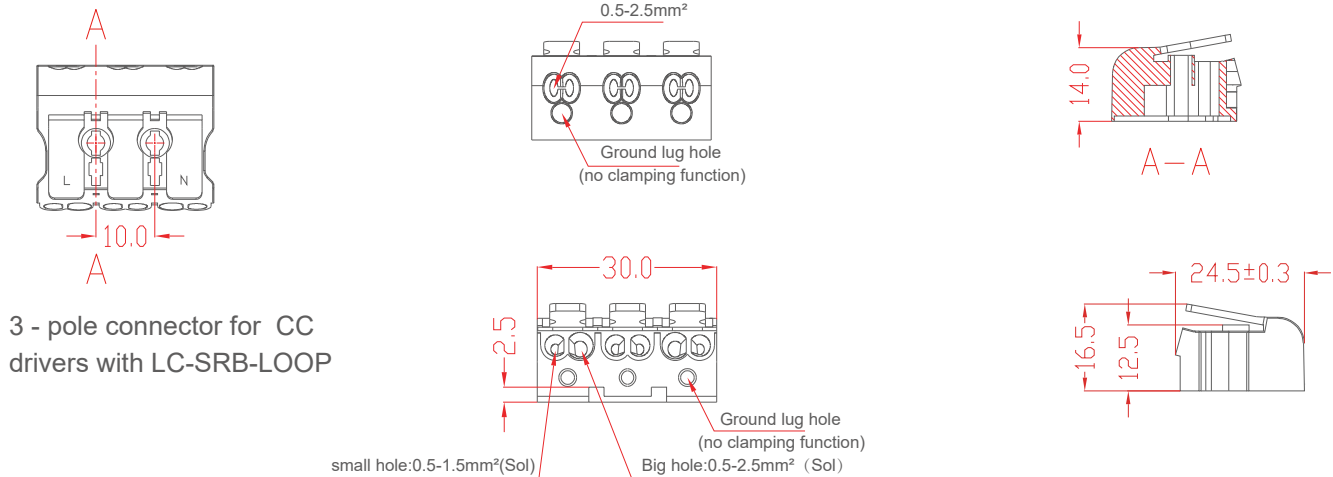

3 - pole connector for CC drivers with LC-SRB-LOOP

Wiring Diagram

Figure: Voltage peaks for LED driver without earthing (Above) and with earthing (Below)

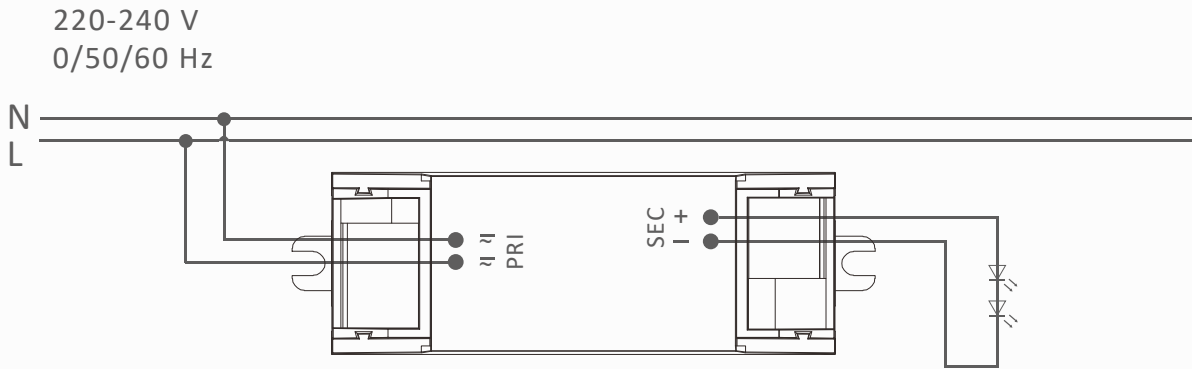

Electrical values

1. Operating power windows

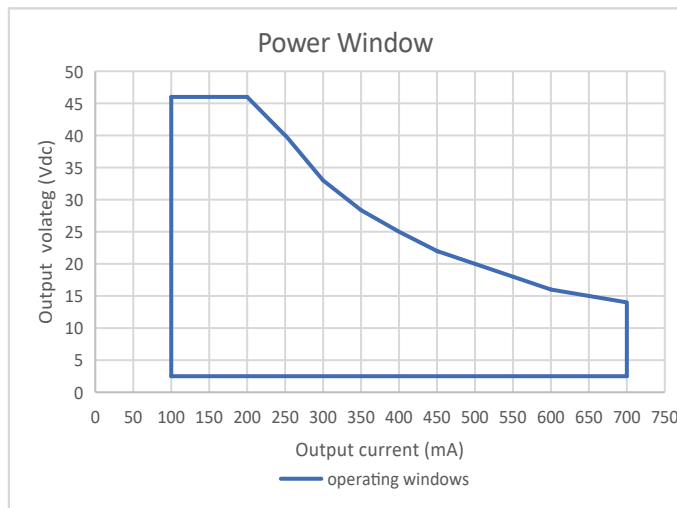

Packing information

Built in type

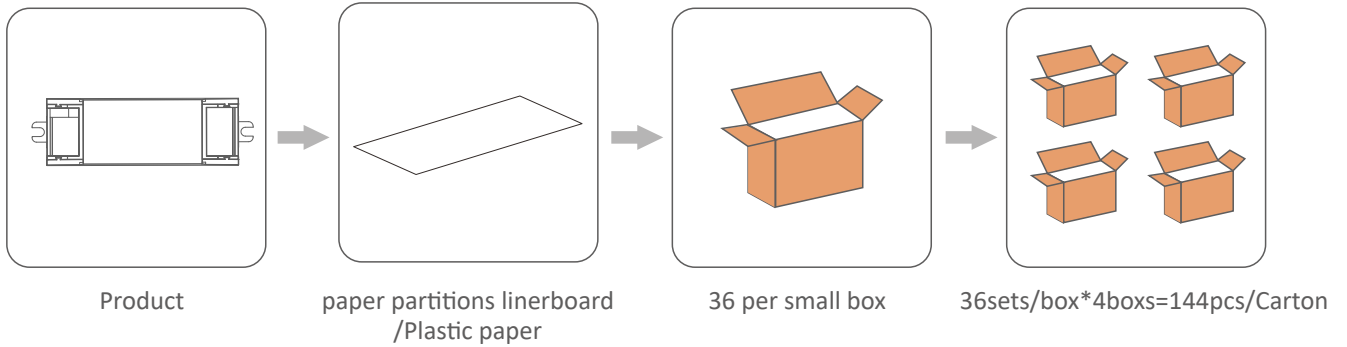

Model	Carton L*W*H(mm)	Pcs/- Carton	Net weight/ Pcs(kg)	Net weight/ Carton(kg)	Cross weight/- Carton(kg)
S-086-C10W100-700 NFC	310*235*230	144	0.076	10.96	11.32

Small Strain reliefs

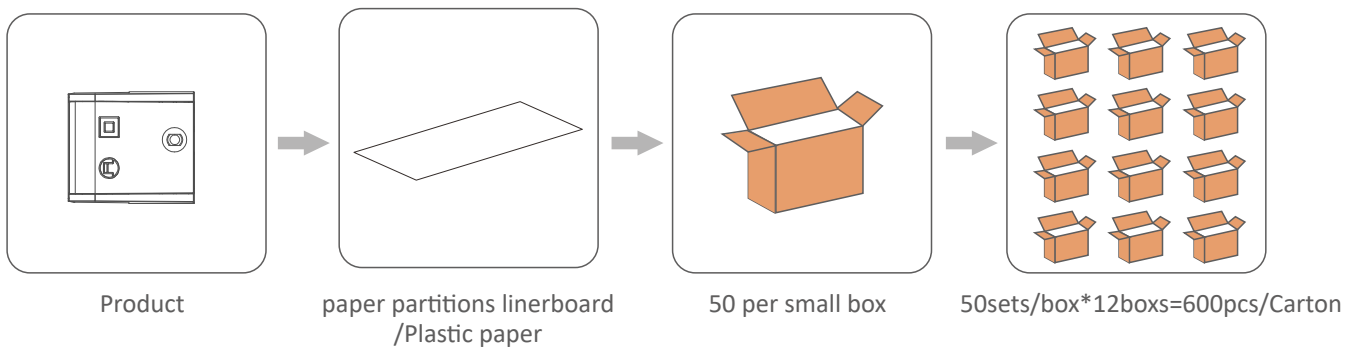

Model	Carton L*W*H(mm)	Pcs/- Carton	Net weight/ Pcs(kg)	Net weight/ Carton(kg)	Cross weight/- Carton(kg)
S-086-C10W100-700 NFC	500*195*245	600	0.007	4.26	5.56

Large Strain reliefs

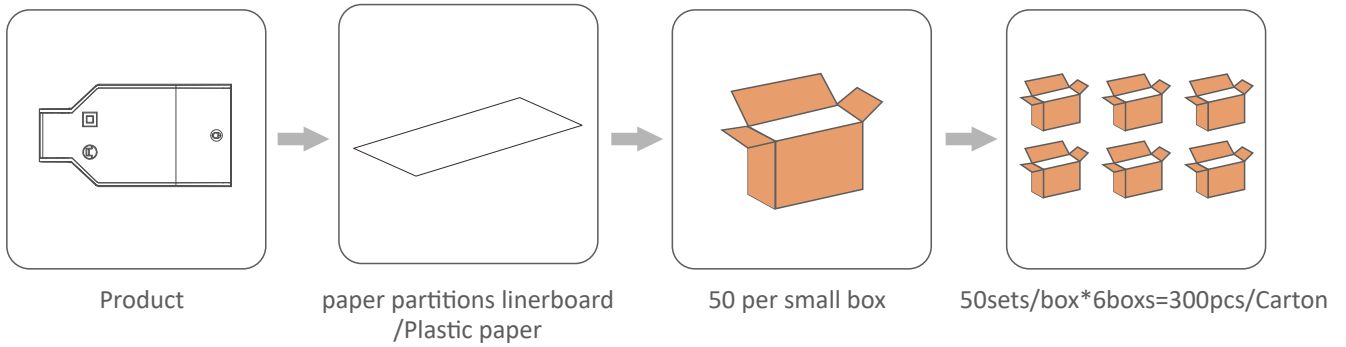

Model	Carton L*W*H(mm)	Pcs/- Carton	Net weight/ Pcs(kg)	Net weight/ Carton(kg)	Cross weight/- Carton(kg)
S-086-C10W100-700 NFC	375*315*385	300	0.041	12.34	13.9





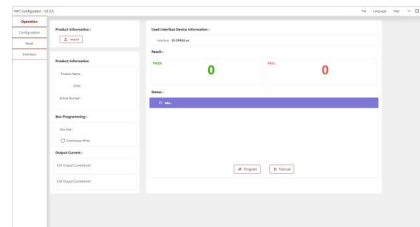
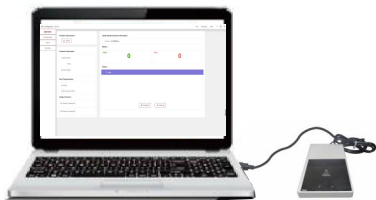

NFC current setting:

NFC Reader (optional)

Feature:

Easily on-line read a output current from a driver or write a new current data to a driver throughout SGN NFC reader within few seconds.



Product	Description	Interface	Matching antenna	Zhaga approval	Usage
 ID CPR30+	Desktop programmer	USB	Integrated	Yes	Single Programming on Desktop
 ID ISC.PRH101-USB	Handheld programmer	USB	Integrated	Yes	Single Programming by Handheld
 ID ISC.MR102-USB	Middle range programmer , for connecting external antenna	USB	RF-MANT12786 	Yes	Single Programming on Product line
 ID ISC.LR1002-E	Long range programmer , for connecting external antenna	USB,RS232,TCP/IP	ID ISC.ANT310/310 	Yes	Multi Programming System

APP NFC

Feature:

Quickly check output current of a LED driver simply via iPhone smart phone, as well as, correct or setup a new current data immediately with no extra equipment at any job site.

ICON



Main



Download method

1.Scan the QR code to download



iPhone smartphones with NFC can be downloaded and used directly

An iPhone smartphone without NFC requires the following devices to use it

Product	Description	Interface	Matching antenna	Zhaga approval	Usage
ID ECCO Smart HF-BLE 	Handheld wireless programmer	USB,Bluetooth LE V4.2 & V5.0	Integrated	Yes	Handheld programming, installation and maintenance work

REVISION HISTORY

Date	Revision	Remark